

CPU Board

EBC 573 Series

User's Manual

Preface

Copyright

This publication, including all photographs, illustrations and software, is protected under international copyright laws, with all rights reserved. No part of this manual may be reproduced, copied, translated or transmitted in any form or by any means without the prior written consent from NEXCOM International Co., Ltd.

Version 1.0

Copyright 2005

Disclaimer

The information in this document is subject to change without prior notice and does not represent commitment from NEXCOM International Co., LTD. However, users may update their knowledge of any product in use by constantly checking its manual posted on our website: <http://www.nexcom.com>. NEXCOM shall not be liable for direct, indirect, special, incidental, or consequential damages arising out of the use of any product, nor for any infringements upon the rights of third parties, which may result from such use. Any implied warranties of merchantability of fitness for any particular purpose is also disclaimed.

Acknowledgements

The EBC573 series is a trademark of NEXCOM international CO., LTD. All other product names mentioned herein are registered trademarks of their respective owners.

Regulatory Compliance Statements

This section provides the FCC compliance statement for Class A devices and describes how to keep the system CE compliant.

Federal Communications Commission (FCC) For Class A Device

This equipment has been tested and verified to comply with the limits for a Class A digital device, pursuant to Part 15 of FCC Rules. These limits are designed to provide reasonable protection against harmful interference when the equipment is operated in a commercial environment. This equipment generates, uses, and can radiate radio frequency energy and, if not installed and used in accordance with the instructions, may cause harmful interference to radio communications. Operation of this equipment in a residential area (domestic environment) is likely to cause harmful interference, in which case the user will be required to

correct the interference (take adequate measures) at their own expense.

CE Certification

The product(s) described in this manual complies with all applicable European Union (CE) directives if it has a CE marking. For computer systems to remain CE compliant, only CE-compliant parts may be used. Maintaining CE compliance also requires proper cable and cabling techniques.

WARNINGS

Read and adhere to all warnings, cautions, and notices in this guide and the documentation supplied with the chassis, power supply, and accessory modules. If the instructions for the chassis and power supply are inconsistent with these instructions or the instructions for accessory modules, contact the supplier to find out how you can ensure that your computer meets safety and regulatory requirements.

CAUTION

Electrostatic discharge (ESD) can damage NSA components. Do the described procedures only at an ESD workstation. If no such station is available, you can provide some ESD protection by wearing an antistatic wrist strap and attaching it to a metal part of the computer chassis.

Safety Information

Before installing and using the EBC573, note the following precautions:

- Read all instructions carefully.
- Do not place the unit on an unstable surface, cart, or stand.
- Follow all warnings and cautions in this manual.
- When replacing parts, ensure that your service technician uses parts specified by the manufacturer.
- Avoid using the system near water, in direct sunlight, or near a hearing device.

Table of Content

Preface	1
Copyright	1
Disclaimer	1
Acknowledgements	1
Regulatory Compliance Statements	1
Federal Communications Commission (FCC) For Class A Device	1
CE Certification	2
Safety Information	2
Table of Content	3
Chapter 1 General Information	
1.1 Main Feature.....	7
1.2 Specifications.....	7
1.3 Power Consumption Measurement.....	10
1.4 Board Layout.....	11
1.5 Board Dimensions.....	12
Chapter 2 Jumper Setting	
2.1 Before You Begin.....	15
2.2 Precautions.....	15
2.3 Setting Jumpers.....	16
2.4 Location of Jumpers.....	17
2.5 Function of Jumper.....	18
2.6 Pin Definition.....	15
Chapter 3 Expansion	
3.1 System Memory.....	36
3.1 System Memory.....	37
3.2 Installing DIMM.....	38
3.3 Installing Compact Flash.....	40
3.4 Installing Intel Pentium-M CPU and Fan Heatsink.....	41
Chapter 4 Award BIOS Setup	
4.1 About the BIOS.....	45
4.2 When to Run BIOS.....	45
4.3 Entering Setup.....	46
4.4 The Main Menu.....	46
4.5 Getting Help.....	47
4.6 Control Keys.....	48
4.7 Standard CMOS Features.....	49

4.8 Advanced BIOS Features.....	51
4.9 Advanced Chipset Features.....	53
4.10 Integrated Peripherals.....	55
4.11 Power Management Setup.....	57
4.12 PnP/PCI Configurations.....	59
4.13 PC Health Status.....	60
4.14 Load Fail-Safe Defaults.....	60
4.15 Load Optimized Defaults.....	60
4.16 Set Password.....	61
4.17 Save & Exit Setup.....	61
4.18 Exit Without Saving.....	61
Appendix A Watchdog Timer	
A.1 Watchdog Timer Working Procedure.....	63
A.2 Watchdog Timer Control Register.....	64
A.3 Watchdog Timer Programming Procedure.....	65
Appendix B GPI/O Programming	
B.1 GPI/O Programming.....	67

Chapter 1

General Information

1.1 Main Feature

Support Intel® Pentium® M/Celeron® M processor up to 2.0GHz+ with 400MHz FSB

- Intel® 852GM chipsets
- 184-pin DIMM x 2, support Max. 2GB DDR 200/266 memory
- Intel® 82551ER 10/100 Fast Ethernet LAN x 2
- Display output via VGA x 1, DVI x 1 or TV-out x 1, LVDS x 1
- Internal Compact Flash x 1
- USB 2.0 Port x 6, COM x 4
- Mini-DIN 4-pin power connector with DC input voltage +12VDC ~ +30VDC support

1.2 Specifications

System Architecture

- Embedded computing board

CPU Support

- Single socket 478 uFCPGA
- Support Intel® Pentium® -M processor: 1MB on die L2 Cache, 400MHz FSB, speed up to 1.7GHz
- Support Intel® Dothan processor: 2MB on die L2 Cache, 400MHz FSB, speed up to 2.0GHz
- Support Intel® Celeron-M processor: 512KB on die L2 Cache, 400MHz FSB, speed from 600MHz
- On-board Intel® Micro-FCBGA 479-pin Pentium® -M/ULV/LV Pentium® -M processor (option, with Min order Q'TY requirement)

Memory

- 184-pin DDR DIMM socket x 2 support un-buffered, non-ECC DDR 200/266 up to 2 GB

BIOS

- Plug & Play support
- Award System BIOS
- 4M bits flash ROM
- ACPI 1.0b compliant

Chipset

- Intel® 82801DB x 1 I/O controller Hub (ICH4)
- Intel® 852GM

LAN

- Intel® 82551ER 10/100 Fast Ethernet LAN x 2

Display

- Intel® 852GM chipset integrated with graphics controller
- Up to 64MB of dynamic video memory allocation
- VGA: DB15 CRT VGA connector x 1, resolution support up to 1600 x 1200 @85Hz and up to 2048 x 1536 @ 75Hz
- LVDS: 44-pin connector x 1, support 18/24-bit single pixel or 18-bit dual pixel LVDS panel (resolution support up to 1400 x 1050)
- On board Chrontel CH7009B DVI/TV out Transmitter x1
- DVI output: 34-pin box header x 1 for DVI 12bit interface, resolution support up to 1600 x 1200
- TV-out: 7-pin mini-DIN for S-video TV-out interface

I/O Interface

- Serial port: One DB44 pin connector with one external cable for 4 COM ports with 16C550 UARTs (3 x RS232 + 1 x RS 232/422/485 via switch selection)
- USB: USB2.0 x 6 ports (4 ports in rear and 2 ports Front with 6-pin JST 2.0mm 6-pin connector)
- LAN: 10/100 Fast Ethernet LAN x 2, RJ45 LAN port x 2
- HDD: 44-pin connector x 1, Ultra ATA33 support (Secondary)
- Internal Compact Flash socket x 1, support One Type II Compace Flash card (Primary)
- Parallel port: bi-directional, EPP/ECP support, DB25 connector x 1
- FDD: supports standard 3.5" floppy drive via box header x 1
- External keyboard/ Mouse: 6-Pin Mini-DIn x 1
- Audio: AC'97 codec with MIC-in and speaker-out (2W amplified) interface
- Digital I/O: 4-bit TTL input, 4-bit TTL output
- On-board buzzer x 1
- SP IrDA x 1
- On-board pin header for Power/HDD Access LED and Reset

Expansion	- Standard 32-bit PCI slot x 1
System Monitor	- Monitor system Voltage, 3 x temperature, 3 x fan speed
Real Time Clock	- On-chip RTC with battery back up - External Lithium battery x 1
Watchdog Timer	- Software selectable time-out interval (1~128 sec. 1~127 min.)
Dimensions Power Requirements	- 260mm (L) x 180mm (W) - 36W measured with Pentium-M 1.6GHz, 1G memory @ HCT program - On board DC to DC converter - Power input: +12VDC to +30VDC input via Mini-DIN 4-pin power connector - Power mode: AT mode
Environments	- Board-level operating temperatures:-20°C to 60°C - Storage temperatures: -20°C to 80°C - Relative humidity: 10% to 90% (Non-condensing)
Certification	- CE - FCC A

Ordering Information

NEW **120W AC Adapter with Keylock (P/N: 7410120002)**
Power Input: 100~240Vac 2A 50/60HZ, Power Output: 24Vdc

EBC573
NEW Socket 478 support Intel® Pentium®-M processor with VGA/LAN x 2/USB2.0 x6/TV-out/DVI/Audio/COM port x 4

EBC573-C65
NEW On-board Intel® Celeron M 600MHz Zero L2 Cache VGA/LAN x 2/USB2.0 x6/TV-out/DVI/Audio/COM port x 4

NEW **Power Cable (P/N: 60233POW33)**
power source from 12Vdc to 30Vdc

1.3 Power Consumption Measurement

Test Configuration:

In Date: 10/19/2004	Out Date: 10/19/2004
BIOS Version: C-005	
Configuration	Model Name
CPU Type/Speed/Model/Micro-Code	Intel Dothan 1.6GHz
Memory Type/Speed/Size/On-Board Chip/Vendor	DDR/DDR333/1GB*2/SAMSUNG
Power Supply Type/Model/Watts-Value	AT/Chroma 6210K-40
PS2 Keyboard and Mouse	Logitech Y-SJ17 Logitech M-S34
HDD Drive	WD WD400
DVD-ROM Devices	MSI C52 (MS-8152)
Floppy Drive	TEAC FD-235HF
Monitor	ViewSonic E70
Operation System	Windows2000 (English)-5.00.2195+SP4
Test Software / Program	HCT 9.5

Test Criteria:

1. Test configuration should include HDD drive, CD-ROM, FDD device.
2. Full loading mode should utilize CPU 100% with run HCT test program.
3. Light loading mode will utilize CPU loading below 5%, and there is no data or application running.

Test Result:

DC Line 12V~30V: (System-Only)	CPU Type: Intel 1.6GHZ	
	12V	30V
Full-Loading Mode (A)	3.1	1.3
Light-Loading Mode (A)	2.2	1.0
Standby Mode (HDD Drive Power-Down) (A)	1.4	0.7

1.4 Board Layout

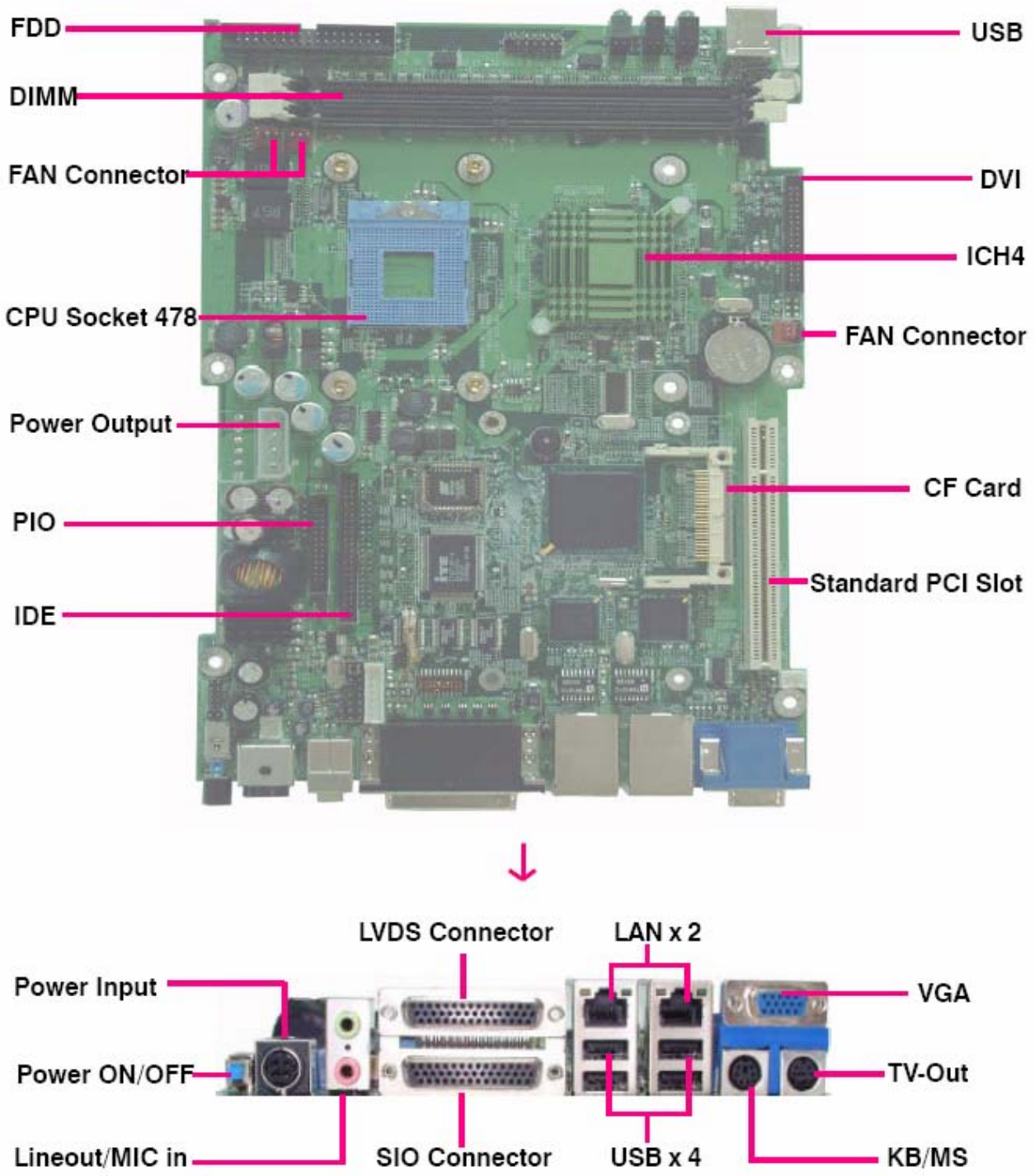

Figure 1.1: Birdeye's View of the EBC573

1.5 Board Dimensions

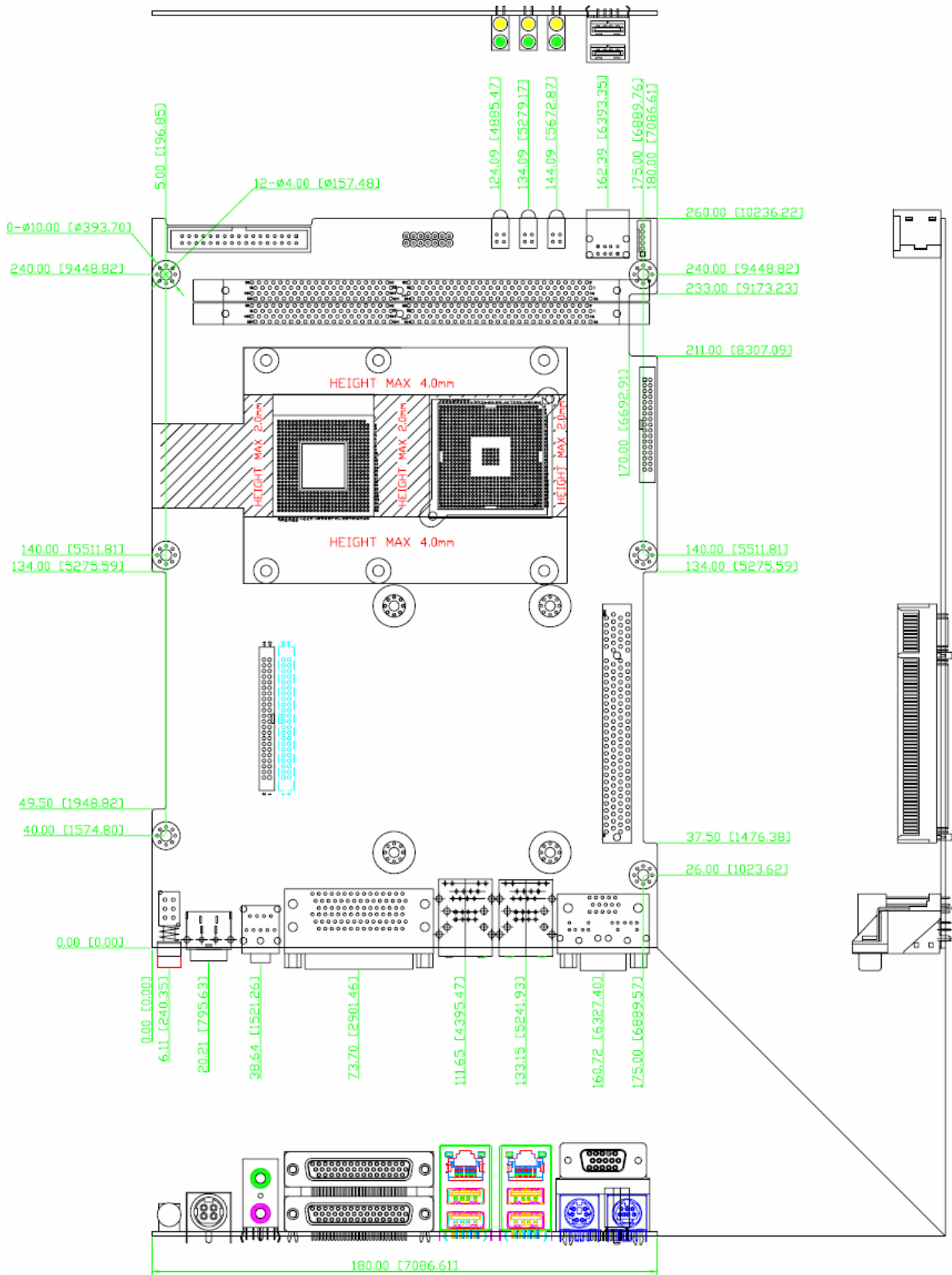

Figure 1.2: Mechanical Drawing of the EBC573

Chapter 2

Jumper Setting

This chapter of the User's Manual describes how to set jumpers.

Note: The procedures that follow are generic for all EBC573 series.

2.1 Before You Begin

Ensure you have a stable, clean working environment. Dust and dirt can get into components and cause a malfunction. Use containers to keep small components separated.

Adequate lighting and proper tools can prevent you from accidentally damaging the internal components. Most of the procedures that follow require only a few simple tools, including the following:

- ◆ A Philips screwdriver
- ◆ A flat-tipped screwdriver
- ◆ A set of jewelers Screwdrivers
- ◆ A grounding strap
- ◆ An anti-static pad

Using your fingers can disconnect most of the connections. It is recommended that you do not use needle-nosed pliers to disconnect connections as these can damage the soft metal or plastic parts of the connectors.

Before working on internal components, make sure that the power is off. Ground yourself before touching any internal components, by touching a metal object. Static electricity can damage many of the electronic components. Humid environment tend to have less static electricity than dry environments. A grounding strap is warranted whenever danger of static electricity exists.

2.2 Precautions

Computer components and electronic circuit boards can be damaged by discharges of static electricity. Working on the computers that are still connected to a power supply can be extremely dangerous. Follow the guidelines below to avoid damage to your computer or yourself:

- ◆ Always disconnect the unit from the power outlet whenever you are working inside the case.
- ◆ If possible, wear a grounded wrist strap when you are working inside the computer case. Alternatively, discharge any static electricity by touching the bare metal chassis of the unit case, or the bare metal body of any other grounded appliance.
- ◆ Hold electronic circuit boards (such as the EBC573 board) by the edges only. Do not touch the components on the board unless it is necessary to do so. Don't flex or stress the circuit board.
- ◆ Leave all components inside the static-proof packaging that they shipped with until they are ready for installation.
- ◆ Use correct screws and do not over tighten screws.

2.3 Setting Jumpers

A jumper is the simplest kind of electric switch. It consists of two metal pins and a cap. When setting the jumpers, ensure that the jumper caps are placed on the correct pins. When the jumper cap is placed on both pins, the jumper is **SHORT**. If you remove the jumper cap, or place the jumper cap on just one pin, the jumper is **OPEN**. Please see the following illustrations

<p>The illustrations on the right show a 2-pin jumper. When the jumper cap is placed on both pins, the jumper is SHORT. If you remove the jumper cap, or place the jumper cap on just one pin, the jumper is OPEN.</p>		
<p>These illustrations show a 3-pin jumper. Pins 1 and 2 are SHORT.</p>		

Table 2-1: Setting Jumpers

2.4 Location of Jumpers

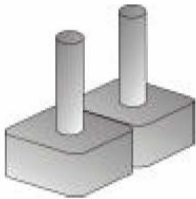
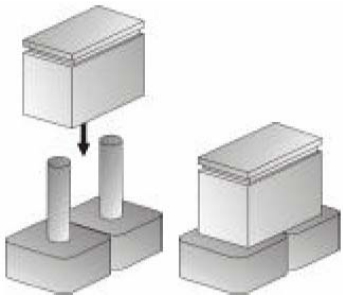
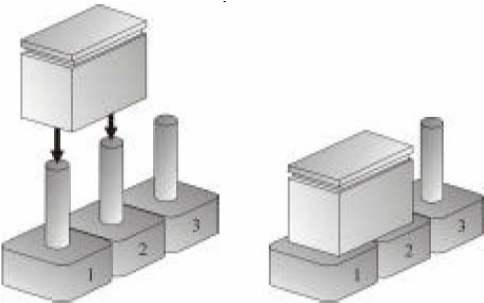
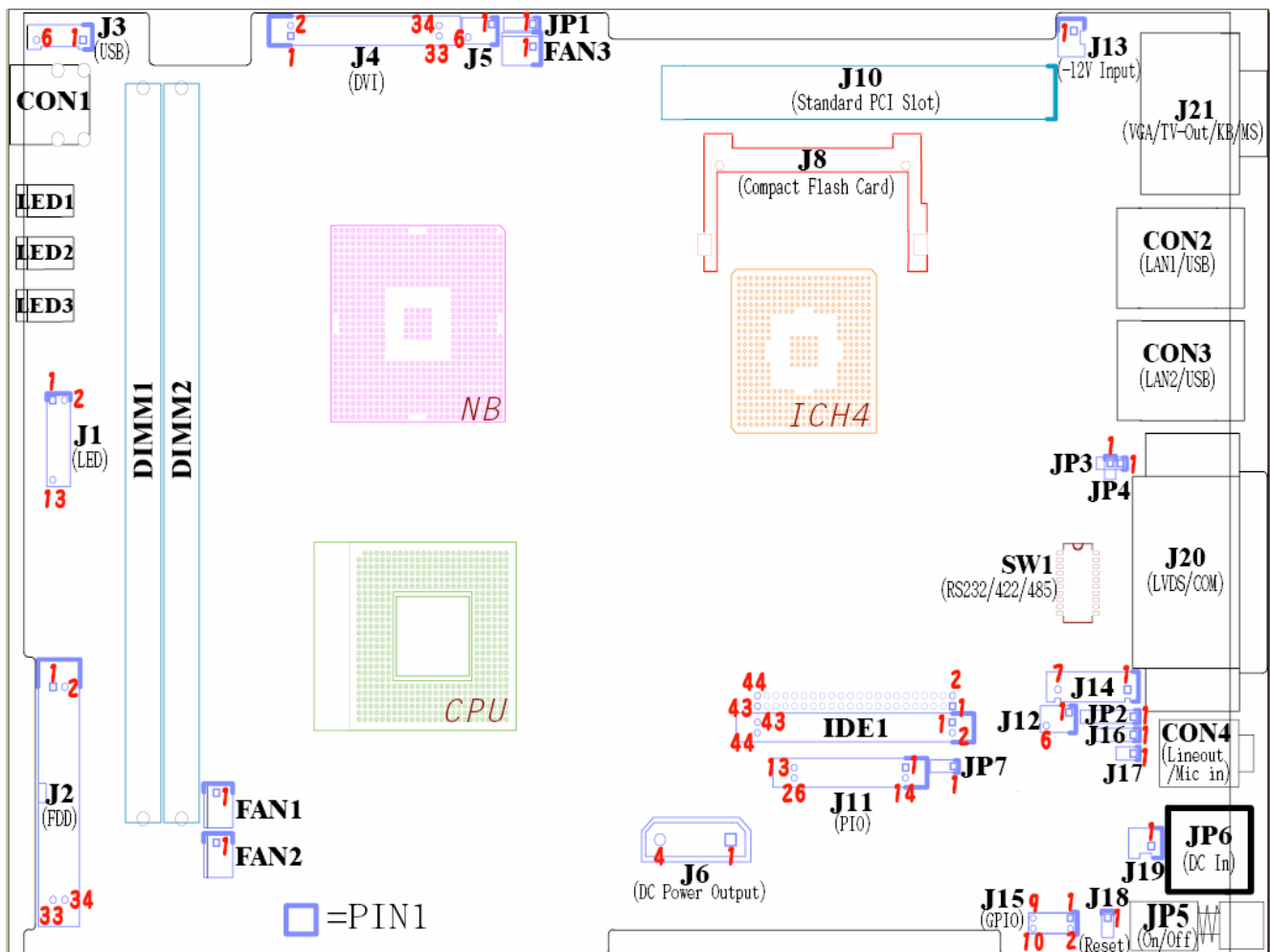

Figure 2-1: Jumper Location

2.5 Function of Jumper

Pin	Function	Pin	Function
JP1	CMOS Status Select	JP7	DC Adapter Input Voltage Select
JP4,JP3	COM4 RI# or Power Status Select	J12	PANEL VDD Select
J5	Pentium M FSB Select	SW1	COM2 RS232/422/485 Select

2.6 Pin Definition

1. IDE connector (IDE1, IDE2)

A. Connector size: 2 x 22 = 44 Pins BOX Header, (2.0 mm Pitch)

B. Connector location:

2 44

○ ○ ○ ○ ○ ○ ○ ○ ○ ○

□ ○ ○ ○ ○ ○ ○ ○ ○ ○

1 43

C. Connector pin definition

Pin	Definition	Pin	Definition
1	RSTDRV-	2	GND
3	IDED7	4	IDED8
5	IDED6	6	IDED9
7	IDED5	8	IDED10
9	IDED4	10	IDED11
11	IDED3	12	IDED12
13	IDED2	14	IDED13
15	IDED1	16	IDED14
17	IDED0	18	IDED15
19	GND	20	NC
21	IDEREQ-	22	GND
23	IDEIOW-	24	GND
25	IDEIOR-	26	GND
27	IDERDY	28	IDE-PD1
29	IDEACK-	30	GND
31	IDEIPQ	32	NC
33	DA1	34	66 DETECT
35	DA0	36	DA2
37	SCS1	38	SCS3
39	IDEACT-	40	GND
41	VCC5	42	VCC
43	GND	44	NC

2. SIO connector (J20A)

- A. Connector size: 3 X 15 = 44 Pin
- B. 44 PIN D-SUB FEMALE



- C. Connector pin definition

Pin	Definition	Pin	Definition
1	DCD	2	RXD
3	TXD	4	DTR
5	GND	6	DSR
7	RTS	8	CST
9	RI	10	GND
11	DCD	12	RXD
13	TXD	14	DTR
15	GND	16	DSR
17	RTS	18	CST
19	RI	20	GND
21	DCD	22	RXD
23	TXD	24	DTR
25	GND	26	DSR
27	RTS	28	CST
29	RI	30	GND
31	DCD	32	RXD
33	TXD	34	DTR
35	GND	36	DSR
37	RTS	38	CST
39	RI	40	GND
41	GP27IN	42	GP26IN
43	GP23OUT	44	GP22OUT

3. PIO connector (J11)

A. Connector size: 2 X 13 = 25 Pin BOX Header (2.0 mm Pitch)

B. Connector location

14 26

○ ○ ... ○ ○

□ ○ ... ○ ○

1 13

C. Connector pin definition

Pin	Definition	Pin	Definition
1	STB#	14	AFD#
2	PD0	15	ERR#
3	PD1	16	PINIT#
4	PD2	17	SLIN#
5	PD3	18	GND
6	PD4	19	GND
7	PD5	20	GND
8	PD6	21	GND
9	PD7	22	GND
10	ACK#	23	GND
11	BUSY	24	GND
12	PE	25	GND
13	SLCT	26	N.C

4. VGA connector (J21C)

A. Connector size: 3 X 5 = 15 Pin

B. 15 PIN D-SUB FEMALE



C. Connector pin definition

Pin	Definition	Pin	Definition
1	RED	2	GREEN
3	BLUE	4	NC
5	GND	6	GND
7	GND	8	GND
9	KEY	10	GND
11	NC	12	ID1
13	HSYNC	14	HSYNC
15	ID3		

5. Key board connector (J21A)

- A. Connector size: Mini din 6 pins
- B. Connector location

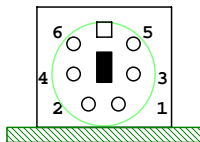

C. Connector pin definition

Pin	Definition	Pin	Definition
1	KBDAT	2	MSDAT
3	GND	4	VCC
5	KBCLK	6	MSCLK

6. LAN connector (CON2/3/AB)

- A. Connector size: RJ-45&USB PORT
- B. Connector location:

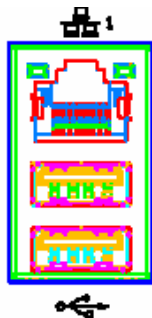

C. LAN Connector pin definition:

Pin	Definition	Pin	Definition
1	BTX+	2	BTX-
3	BRX+	4	TERM PLANE
5	TERM PLANE	6	BRX-
7	TERM PLANE	8	TERM PLANE

D. USB Connector pin definition

Pin	Definition	Pin	Definition
1	USB POWER +5V	2	USB PORT * D-
3	USB PORT * D+	4	GROUND POWER
5	USB POWER +5V	6	USB PORT * D-
7	USB PORT * D+	8	GROUND POWER

7. USB connector (CON1)

A. Connector size : USB PORT

B. Connector location:

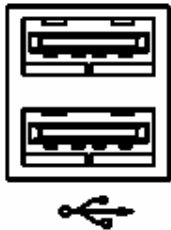

C. Connector pin definition

Pin	Definition	Pin	Definition
1	USB POWER +5V	2	USB PORT * D-
3	USB PORT * D+	4	GROUND POWER
5	USB POWER +5V	6	USB PORT * D-
7	USB PORT * D+	8	GROUND POWER

8. USB connector (J3)

- A. Connector size: 1 X 6 = JST 6PIN HEADER (2.00mm Pitch)
- B. Connector location

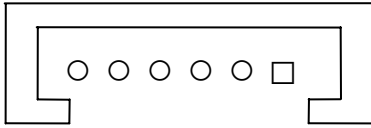

- C. Connector pin definition

Pin	Definition	Pin	Definition
1	USBVCC	2	USB1D-
3	USB1D+	4	USB2D-
5	USB2D+	6	USBGND

9. AUDIO CD- IN (J16)

- A. Connector size: 1 X 4 = 4 Pin Header (2.54mm Pitch)
- B. Connector location



1 2 3 4

- C. Connector pin definition

Pin	Definition	Pin	Definition
1	CD IN - L	2	AUDIO GROUND POWER
3	AUDIO GROUND POWER	4	CD IN - R

10. POWER ON/OFF (JP5)

11. AUDIO LINE (CON4B)

OUT PHONE JACK



AUDIO MIC IN (CON4A)

PHONE JACK

12. POWER INPUT (JP6)

DC Adapter Board Power Input Connector



13. POWER SUPPLY (J7)

POWER SUPPLY Power Input Connector

- A. Connector size: 1X6 = 6 Pin (3.96mm Pitch)
- B. Connector location

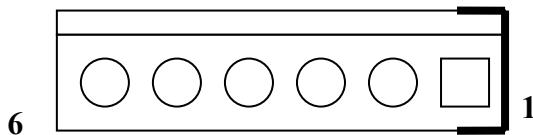

Connector pin definition

Pin	Name		Color	Description
1	+12V		Yellow	+12 VDC
2	GND		Black	Ground
3	GND		Black	Ground
4	GND		Black	Ground
5	+5V		Red	+5 VDC
6	+5V		Red	+5 VDC

14. POWER OUTPUT (J6)

DC Adapter Board Power Output Connector

A. Connector size: 1X4= 4 Pin (3.96mm Pitch)

B. Connector location

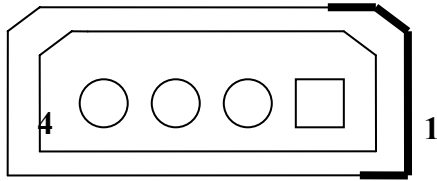

C. Connector pin definition

Pin	Name		Color	Description
1	+12V		Yellow	+12 VDC
2	GND		Black	Ground
3	GND		Black	Ground
4	+5V		Red	+5 VDC

15. GPIO connector (J15)

A. Connector size: 2 X 5 = 10 Pin Header (2.00mm Pitch)

B. Connector location

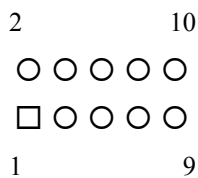

C. Connector pin definition

Pin	Definition	Pin	Definition
1	GP27IN (PIN20)	2	GP23OUT (PIN24)
3	GP26IN (PIN21)	4	GP22OUT (PIN25)
5	GP25IN (PIN22)	6	GP21OUT (PIN26)
7	GP24IN (PIN23)	8	GP20OUT (PIN27)
9	VCC5	10	GND

16. SMBUS connector (J17)

A. Connector size: 1 X 2 = 2 Pin Header (2.54mm Pitch)

B. Connector location



1 2

C. Connector pin definition

Pin	Definition	Pin	Definition
1	SMBDATA	2	SMBCLK

17. FAN POWER connector (FAN1,FAN2,FAN3)

A. Connector size: 1 X 3 = 3PIN W/FAN (2.54mm Pitch)

B. Connector location

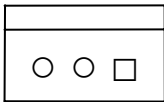

C. Connector pin definition

Pin	Definition	Pin	Definition
1	GND	2	+12V
3	Sensor		

18. POWER ON & IDE & LAN Link/Active LED connector (J1)

A. Connector size: 2 X 7 = 13 Pin Header (2.54mm Pitch)

B. Connector location

2 12



1 13

C. Connector pin definition

Pin	Definition	Pin	Definition
1	GND	2	ONLED
3	IDE Active	4	IDEACT#
5	SPEED_LAN1	6	LAN1_VCC
7	LILED_LAN1	8	ACTLED_LAN1
9	SPEED_LAN1	10	LAN2_VCC
11	LILED_LAN1	12	ACTLED_LAN2
13	NC		

18. POWER ON & IDE Active LED (LED1)

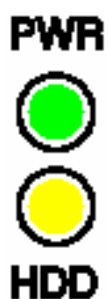

19. LAN1 Link/Active LED (LED2)



LAN2 Link/Active LED (LED3)

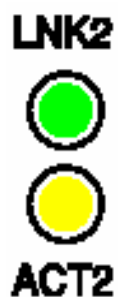

20. Hardware Reset connector (J18)

A. Connector size: 1 X 2 = 2 Pin Header (2.54 Pitch)

B. Connector location

1 2

□ ○

C. Connector pin definition

Pin	Definition	Pin	Definition
1	GND	2	Reset

21. PCI1 - STANDARD PCI SLOT (J10)

STANDARD 5V / 32BIT / 33MHZ PCI SLOT

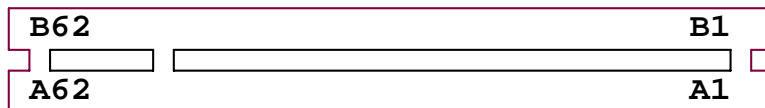

22. J8 – COMPACTFLASH SOCKET

(PRIMARY CHANNEL: DEFAULT MASTER)

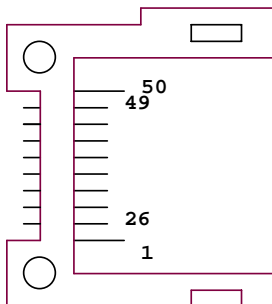

23. TV-OUT (J21B)

A. Connector size: MINI DIN 7PIN

B. Connector location



C. Connector pin definition

Pin	Definition
1	VEDIO
2	GND
3	S-VEDIOC
4	GND
5	S-VEDIOV
6	GND

24. External thermal connector (J19)

A. Connector size: 1 X 2 = 2 Pin JST (2.5 Pitch)

B. Connector location

2 1

○ □

C. Connector pin definition

Pin	Definition	Pin	Definition
1	GNDA	2	External thermal Input

25. IRDA connector (JP2)

A. Connector size: 1 X 5 = 5 Pin Header (2.54mm Pitch)

B. Connector location

□ ○ ○ ○ ○

1 5

C. Connector pin definition

Pin	Definition
1	VCC5
2	CIRRX
3	IRRX
4	GND
5	IRTX

26. CCFL connector (J14)

A. Connector size: 1 X 7 = 7 Pin JST (2.5 Pitch)

B. Connector location

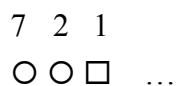

C. Connector pin definition

Pin	Definition	Pin	Definition
1	VDD(5V or 3.3V)	5	GND
2	BACKLIGHT	6	GND
3	BACKLIGHT	7	BKLTCTL
4	BL_VR		

27. Floppy connector (J2)

A. Connector size: 2 X 17 = 34 BOX Header (2.54mm Pitch)

B. Connector location

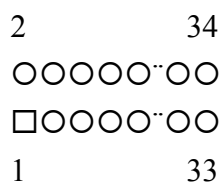

C. Connector pin definition

PIN	Description	PIN	Description
1	Ground	2	Drive Density Select 0
3	Ground	4	NC
5	Ground	6	NC
7	Ground	8	Index Pulse Input
9	Ground	10	Motor On 0
11	Ground	12	Drive Select 1
13	Ground	14	Drive Select 0
15	Ground	16	Motor On 1
17	Ground	18	Step Direction
19	Ground	20	Step Pulse
21	Ground	22	Write Disk Data
23	Ground	24	Write Gate
25	Ground	26	Track 0
27	Ground	28	Write Protected
29	Ground	30	Read Disk Data
31	Ground	32	Head Select
33	Ground	34	Disk Change

28. COM4 RI# or Power Status Select (JP4,JP3)

Pin	Status	Function Description
JP4 1-2	Short*	RI#
JP3 1-2	Short	Select +5V
JP3 2-3	Short	Select +12V

29. DVI (J4)

A. Connector size: 2 X 17 = 34 BOX Header (2.0mm Pitch)

B. Connector location

2 34
 ○○○○○○●○○
 □○○○○○●○○
 1 33

C. Connector pin definition

PIN	Description	PIN	Description
1	Analog GND	2	Analog GND
3	T.M.D.S Data2-	4	T.M.D.S Data2+
5	GND	6	NC
7	NC	8	DDC Clock
9	DDC Data	10	NC
11	T.M.D.S Data1-	12	T.M.D.S Data1+
13	Analog GND	14	NC
15	NC	16	+5V
17	Analog GND	18	Hot Plug Detect
19	T.M.D.S Data0-	20	T.M.D.S Data0+
21	Analog GND	22	NC
23	NC	24	GND
25	T.M.D.S CLK+	26	T.M.D.S CLK-
27	GND	28	GND
29	NC	30	NC
31	NC	32	Analog GND
33	Analog GND	34	NC

30. ANEL VDD Select (J12)

Pin	Status	Function Description
1-3;2-4	Short	VCC5
3-5;4-6	Short*	VCC3

31. External -12V Input connector (J13)

A. Connector size: 1 X 2 = 2 Pin JST (2.5 Pitch)

B. Connector location

2 1

○ □

C. Connector pin definition

Pin	Definition	Pin	Definition
1	-12V	2	GND

32. LVDS connector (J20B)

A. Connector size: 3 X 15 = 44 Pin

B. 44 PIN D-SUB FEMALE



C. Connector pin definition

Pin	Definition	Pin	Definition	Pin	Definition
1	DDCPCLK	16	DDCPDATA	31	GND
2	CLKBM	17	LCKBP	32	GND
3	YBM3	18	YBP3	33	GND
4	YBM2	19	YBP2	34	GND
5	YBM1	20	YBP1	35	GND
6	YBM0	21	YBP0	36	GND
7	CLKAM	22	LCKAP	37	GND
8	YAM3	23	YAP3	38	GND
9	YAM2	24	YAP2	39	GND
10	YAM1	25	YAP1	40	GND
11	YAM0	26	YAP0	41	VDD(5V or 3.3V)
12	BKLTCTL	27	VR	42	VDD(5V or 3.3V)
13	VDD(5V or 3.3V)	28	VDD(5V or 3.3V)	43	BACKLIGHT

14	BACKLIGHT	29	BACKLIGHT	44	BACKLIGHT
15	BACKLIGHT	30	BACKLIGHT		

PS: BACKLIGHT is backlight inverter Power

Marked “*” was the default setting.

33. COM2 RS232/422/485 Select (SW1)

Mode	1	2	3	4	5	6	7	8	9	10
RS232*	OFF	OFF	OFF	ON	OFF	ON	OFF	OFF	OFF	OFF
RS422	OFF	OFF	ON	OFF	ON	OFF	ON	ON	ON	ON
RS485	ON	ON	OFF	ON	ON	OFF	OFF	OFF	OFF	ON

34. Pentium M FSB Select (J5)

Pin No.	Status	Function Description
1-3;2-4	Short*	400Mhz
3-5;4-6	Short	533Mhz

35. DC Adapter Input Voltage Select (JP7)

Pin No.	Status	Function Description
1-2	Short	8V-30V
2-3	Short*	12V-30V

36. CMOS Status Select (JP1)

Pin No.	Status	Function Description
1-2	Short*	Normal Operation
2-3	Short	Clear CMOS Data

Power supply must consumed watts and currents

Power Type	+12V	12V to +5V	Total Watt
Consumed watts	48W	72.27W	120.27
Consumed currents (Item A)	4	14.45A	120.27
Actually required currents (Item A/0.8)	5	18	150

Key component power consumption (Unit : A)

Chipset	Vcore 0.7~1.7	Vccp 1.05	1.35V	+1.25V	+1.5V	+1.8V	+2.5V	+3.3V	+5V	+12v
Pentium M	25	□	□	□	□	0.5	□	□	□	□
INTEL 82852GM	□	2.4	1.8	0.01	0.32	□	0.05	□	□	□
DIMM X2	□	□	□	1.5	□	□	8	□	□	□
INTEL ICH4 (82801B)	□	□	□	□	0.5	□	□	0.65	□	□
CLOCK GEN. (CK-408)	□	□	□	□	□	□	□	0.28	□	□
INTEL 82551ER	□	□	□	□	□	□	□	0.31	□	□
CH7009B	□	□	□	□	0.00 4	□	□	0.3	□	□
Super IO (ITE8712)	□	□	□	□	□	□	□	□	1	□
Super IO (ITE8710)	□	□	□	□	□	□	□	0.6	□	□
Other	□	□	□	□	□	□	□	2	□	4
	□	□	□	□	□	□	□	□	□	□
Total consumption	25	2.4	1.8	1.51	0.824	0.5	8.05	4.14	1	4
Total Watt (Unit: W)	24.5	2.52	2.43	1.89	1.24	0.9	20.13	13.66	5	48
Transfer Voltage (Unit: V)	12 to 5	12 to 5	12 to 5	12 to 5	12 to 5	12 to 5	12 to 5	12 to 5	12 to 5	12

Chapter 3

Expansion

3.1 System Memory

Your system memory is provided by DIMM's (Dual In-Line Memory Modules) on the CPU board. The board contains two memory banks: Bank 0 and 1, which correspond to connector DIMM1 and DIMM2. The table below shows possible DIMM Configurations for the memory banks. Please note that the EBC573 supports Double Data Rate DDR 200/266/333 SDRAM. Configurations using different brands of memory modules are not recommended.

DIMM1	DIMM2	Total Memory
128 MB	Empty	128 MB
Empty	128 MB	128 MB
128 MB	128 MB	256 MB
256 MB	Empty	256 MB
Empty	256 MB	256 MB
256 MB	256 MB	512 MB
512 MB	Empty	512 MB
Empty	512 MB	512 MB
512 MB	512 MB	1024 MB
1024 MB	Empty	1024 MB
Empty	1024 MB	1024 MB
1024 MB	1024 MB	2048 MB

Table 3-1: DIMM Configurations of the EBC573

3.2 Installing DIMM

To install DIMM

1. Make sure the two handles of the DIMM sockets are in the “open” position, i.e. the handles stay outward.

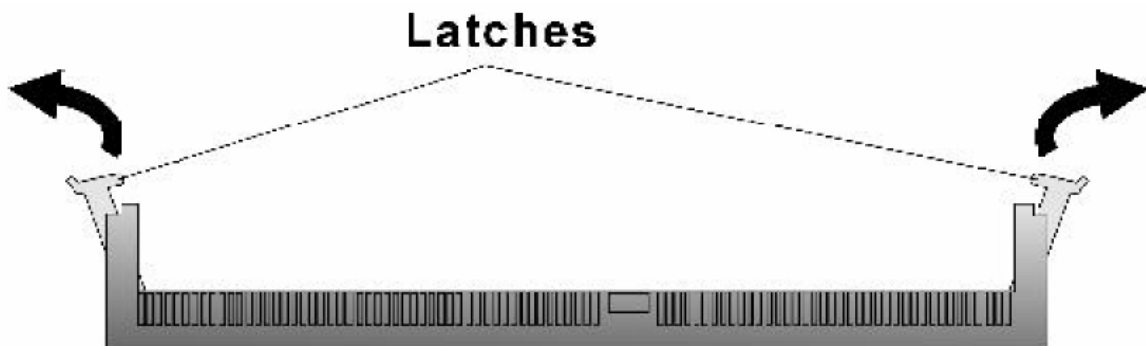

Figure3-1: How to Install DIMM (1)

2. Slowly slide the DIMM modules along the plastic guides in the both ends of the socket.

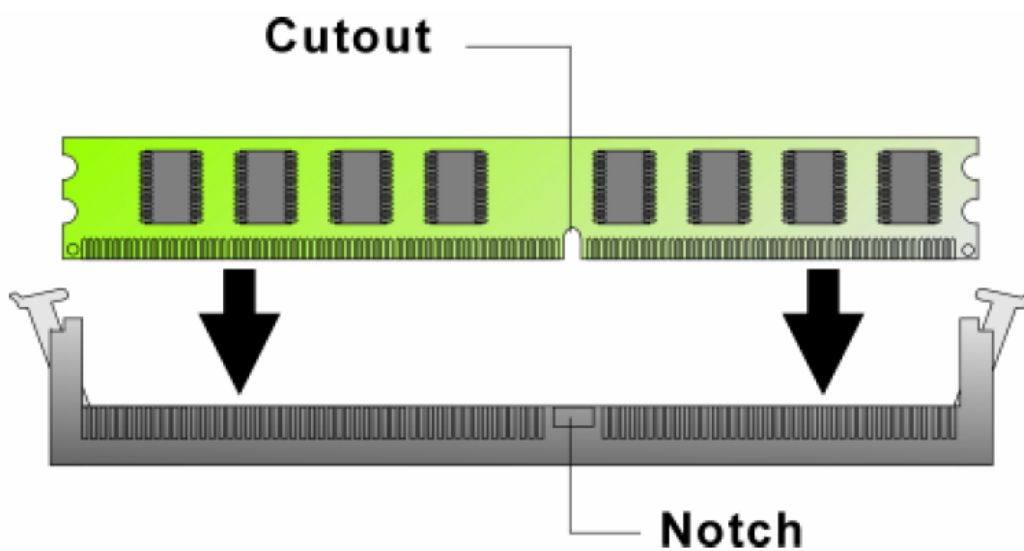

Figure 3-2: How to Install DIMM (2)

3. Then press the DIMM module down right into the socket, until a click is heard. That means the two handles automatically locked the memory modules into the right position of the DIMM socket.

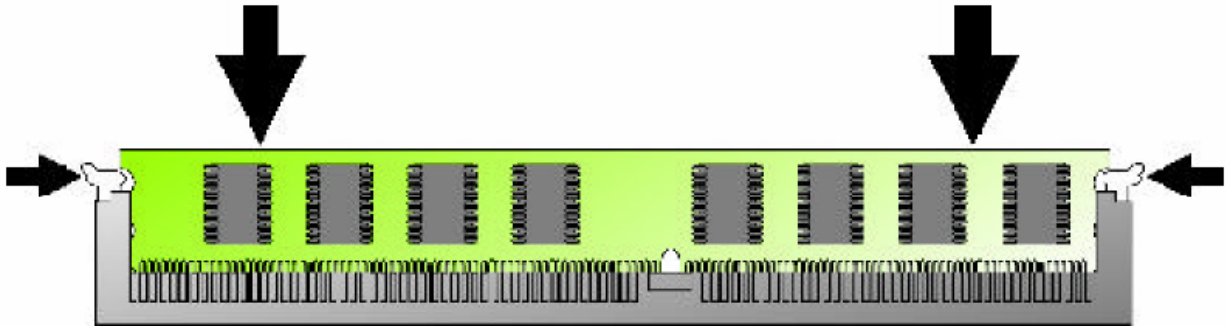

Figure 3-3: How to Install DIMM (3)

4. To take away the memory module, just push the both handles outward, the memory module will be ejected by the mechanism in the socket.

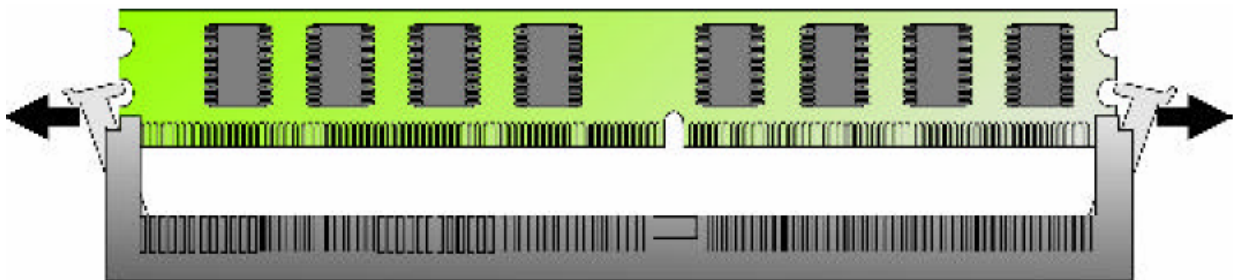

Figure 3-4: How to Install DIMM (4)

3.3 Installing Compact Flash

1. To install a Compact Flash memory card into EBC573, align the notches on the card with the Compact Flash socket in the EBC573. Then firmly insert the card into the socket until it is completely seated.

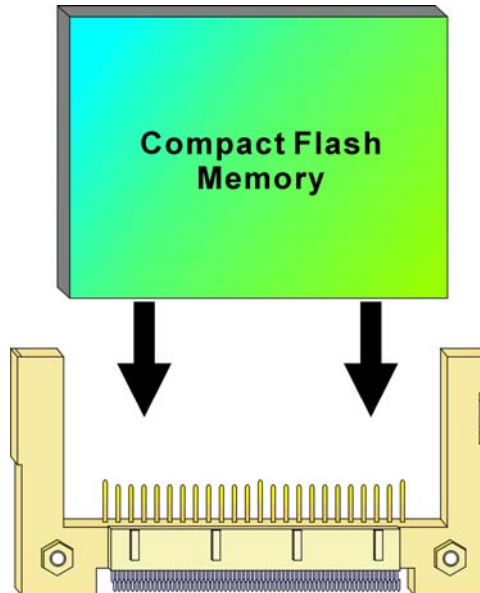

Figure 3-5: How to Install Compact Flash Memory (1)

2. To remove the Compact Flash memory card from EBC573, pull out the memory card from the Compact Flash socket.

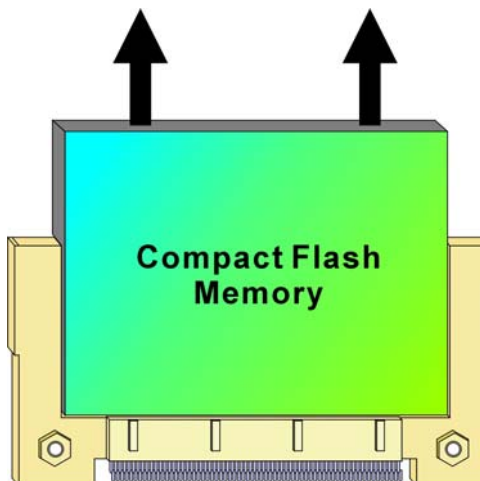

Figure 3-6: How to Uninstall Compact Flash Memory (2)

3.4 Installing Intel Pentium-M CPU and Fan Heatsink

Below is the installation instruction:

Note: Prepare a slot type screwdriver before starting the installation process.

Step1: Be sure that the beveled corner of the CPU as shown in the picture is aligned with that of the socket.

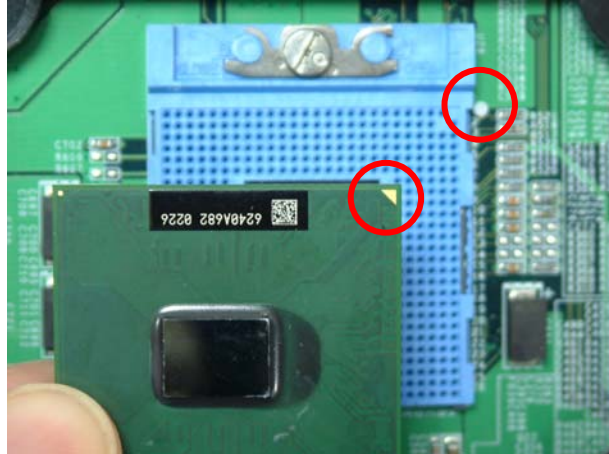

Figure 3-7: How to Install CPU (1)

Step2: Screw it tight as shown in the picture.

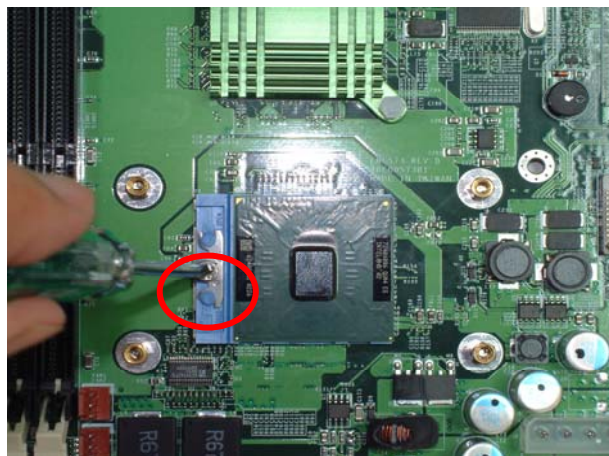

Figure 3-8: How to Install CPU (2)

Step3: Apply the heatsink ointment to the location on the CPU as indicated by the arrow.



Figure 3-9: How to Install CPU (3)

Step4: Attach the heatsink onto the CPU. The exhaust opening should face the Northbridge. Connect the power connector to the jumper and tighten the four screws as shown.

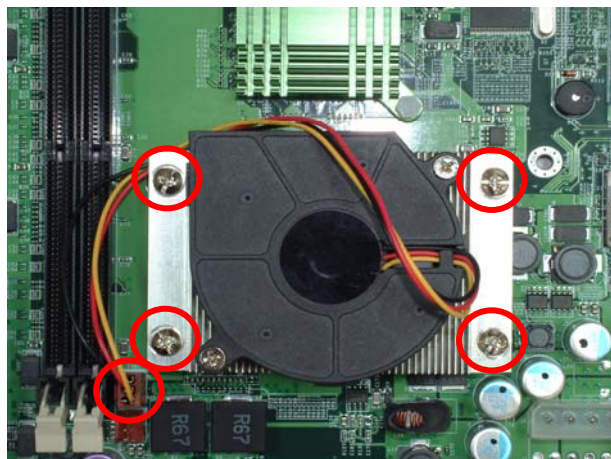

Figure 3-10: How to Install fan heatsink (1)

Chapter 4

Award BIOS Setup

This chapter explains how to use the BIOS Setup program for the EBC573. The current BIOS setup pictures in the chapter are for reference only, which may change by the BIOS modification in the future. User can download any major updated items or reversion from NEXCOM web site <http://www.nexcom.com.tw>. If any unclear message occurs, please contact NEXCOM customer service representative for help or log onto <http://www.nexcom.com.tw/contact/contact.htm>.

4.1 About the BIOS

The BIOS (Basic Input and Output System) Setup program is a menu driven utility that enables you to make changes to the system configuration and tailor your system to suit your individual work needs. It is a ROM-based configuration utility that displays the system's configuration status and provides you with a tool to set system parameters. These parameters are stored in non-volatile battery-backed-up CMOS RAM that saves this information even when the power is turned off. When the system is turned back on, the system is configured with the values found in CMOS.

With easy-to-use pull down menus, you can configure such items as:

- ◆ Hard drives, diskette drives, and peripherals
- ◆ Video display type and display options
- ◆ Password protection from unauthorized use
- ◆ Power management features

The settings made in the Setup program intimately affect how the computer performs. It is important, therefore, first to try to understand all the Setup options, and second, to make settings appropriate for the way you use the computer.

4.2 When to Run BIOS

This program should be executed under the following conditions:

- ◆ When changing the system configuration
- ◆ When a configuration error is detected by the system and you are prompted to make changes to the Setup program
- ◆ When resetting the system clock
- ◆ When redefining the communication ports to prevent any conflicts
- ◆ When making changes to the Power Management configuration
- ◆ When changing the password or making other changes to the security setup

Normally, CMOS setup is needed when the system hardware is not consistent with the information contained in the CMOS RAM, whenever the CMOS RAM has lost power, or the system features need to be changed.

Standard CMOS Features

Use this menu for basic system configuration.

Advanced BIOS Features

Use this menu to set the Advanced Features available on the system.

Advanced Chipset Features

Use this menu to change the values in the chipset registers and optimize the system's performance.

Integrated Peripherals

Use this menu to specify your settings for integrated peripherals.

Power Management Setup

Use this menu to specify your settings for power management.

PnP/PCI Configurations

This entry appears if your system supports Plug and Play and PCI Configuration.

PC Health Status

Displays CPU, System Temperature, Fan Speed, and System Voltages Value.

Load Fail-Safe Defaults

Use this menu to load the BIOS default values for the minimal/stable performance for your system to operate.

Load Optimized Defaults

Use this menu to load the BIOS default values, i.e., factory settings for optimal performance system operations. While Award has designed the custom BIOS to maximize performance, the factory has the option to change these defaults to meet their needs.

Set Password

Enables you to change, set, or disable the supervisor or user password.

Save & Exit Setup

Saves CMOS value changes to CMOS and exits setup

Exit Without Saving

Ignores all CMOS value changes and exits setup.

4.5 Getting Help















Main Menu

The on-line description of the highlighted setup function is displayed at the bottom of the screen.

Status Page Setup Menu/Option Page Setup Menu

4.6 Control Keys

The table below lists the keys that help you navigate the setup program.

Up arrow		Move to previous item
Down arrow		Move to next item
Left arrow		Move to the item to the left
Right arrow		Move to the item to the right
Esc key		Main Menu: Quit without saving changes to CMOS Status/Option Page Setup Menus: Exit current page and return to Main Menu.
Enter Key		Select or Accept an Item
PgUp/plus key		Increase the numeric value or make changes
PgDn/minus key		Decrease the numeric value or make changes
F1 key		General help, only for Status Page Setup Menu and Option Page Setup Menu
F2/Shift + F2 key		Change color from total 16 colors. F2 to select color forward, (Shift) F2 to select color backward
F5 key		Restore the previous CMOS value from CMOS (only for Option Page Setup Menu)
F6 key		Load the default CMOS value from BIOS default table (only for Option Page Setup Menu)
F7 key		Load the Setup default value (only for Option Page Setup Menu)
F9 Key		Menu in BIOS
F10 key		Save all the CMOS changes (only for Main Menu)

4.7 Standard CMOS Features

Selecting Standard CMOS Features on the main program screen displays the following menu:

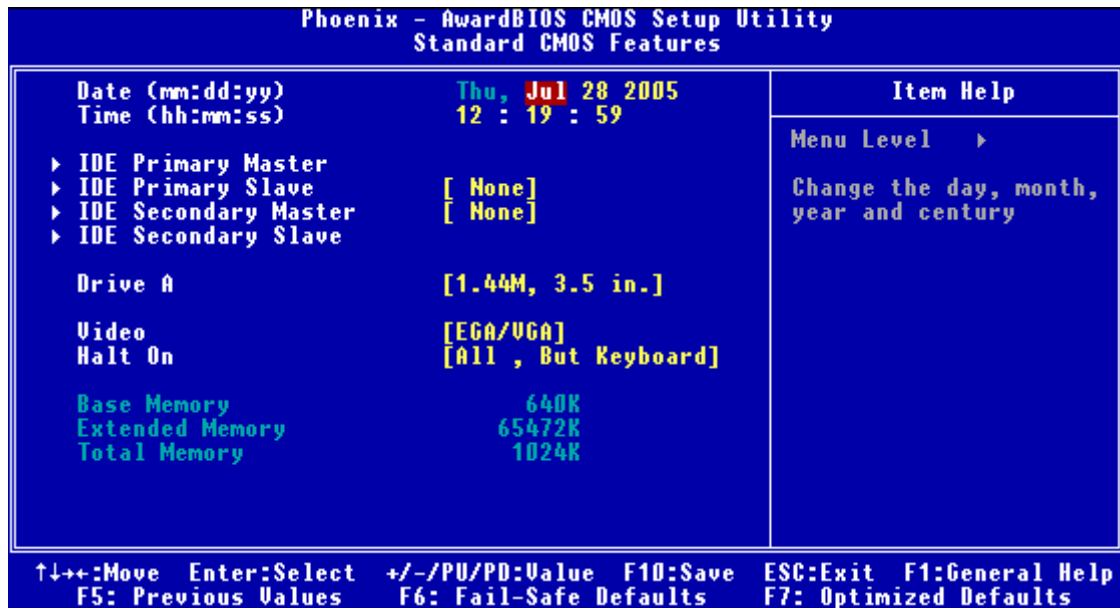

Figure 4-2: BIOS – Standard CMOS Features

The Standard CMOS Setup utility is used to configure the following features:

Date (mm:dd:yy)

The BIOS determines the day of the week from the other data information. This field is for information only. Press the left or right arrow key to move to the desired field (date, month, year). Press the PgUp or PgDn key to increment the setting, or type the desired value into the field.

Time (hh:mm:ss)

The time format is based on the 24-hour military time clock. For example, 1 p.m. is 13:00:00. Press the left or right arrow key to move to the desired field. Press the PgUp or Pg Dn key to increment the setting, or type the desired value into the field.

IDE Devices (Primary/Secondary Master/Slave)

Your computer has two IDE channels (Primary and Secondary) and each channel can be installed with one or two devices (Master and Slave). Use these items to configure each device on the IDE channel. If you leave this item at Auto, the system will automatically detect and configure any IDE devices it finds. If it fails to find a hard disk, change the value to Manual and then manually configure the drive by entering the characteristics of the drive in the items below:

- ◆ Capacity Approximate hard disk drive capacity
- ◆ Cylinder Number of cylinders
- ◆ Head Number of heads
- ◆ Precomp Write pre-compensation cylinder

- ◆ Landing Zone Landing zone
- ◆ Sector Number of sector

Refer to your drive's documentation or look on the drive if you need to obtain this information. If no device is installed, change the value to None.

Drive A

Select this field to the type of floppy disk drive installed in your system. The choices are:

- ◆ None: No floppy drive installed
- ◆ 360K, 5.25 in: 5-1/4 inch PC type standard drive; 360 kilobyte capacity
- ◆ 1.2M, 5.25 in: 5-1/4 inch AT-type high-density drive; 1.2 megabyte capacity
- ◆ 720K, 3.5 in: 3-1/2 inch double-sided drive; 720 kilobyte capacity
- ◆ 1.44M, 3.5 in: 3-1/2 inch double-sided drive; 1.44 megabyte capacity
- ◆ 2.88M, 3.5 in: 3-1/2 inch double-sided drive; 2.88 megabyte capacity

Note: The None option could be used for diskless workstations.

Video

Set this field to the type of graphics card installed in your system. If you are using a BGA or higher resolution card, choose the EGA/VGA option. The options are:

- ◆ EGA/VGA Enhanced Graphics Adapter/Video Graphics Array. For EGA, VGA, SEGA or PGA monitor adapters
- ◆ CGA40 Color Graphics Adapter, power up in 40 column mode
- ◆ CGA80 Color Graphics Adapter, power up in 80 column mode
- ◆ MONO Monochrome adapter, includes high resolution monochrome adapters

Halt On

During the Power-On Self-Test (POST), the computer stops if the BIOS detect a hardware error. This setting determines which type of error will cause the system to halt during boot. The options are:

- ◆ All Error: Whenever the BIOS detects a non-fatal error, the system will be stopped and you will be prompted.
- ◆ No Errors: The system boot will not stop for any error that may be detected.
- ◆ All, But Keyboard: The system boot will not stop for a keyboard error, but it will stop for all others.

After you have made your selections in the Standard CMOS Setup screen, press <ESC> to go back to the main screen.

4.8 Advanced BIOS Features

Selecting Advanced BIOS Feature on the main program screen displays this menu, which allows you to define advanced information about your system. You can make modifications to most of these items to improve your system performance or set up system features according to your preference, without causing fatal errors to your system.

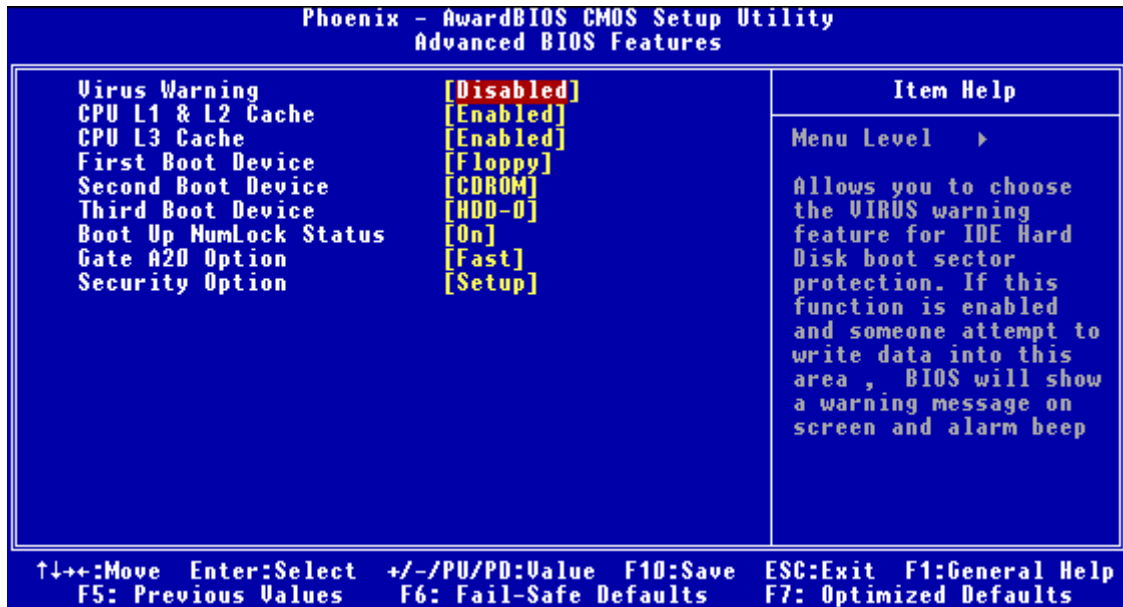

Figure 4-3: BIOS – Advanced BIOS Features

The following explains the options for each feature:

Virus Warning

Allow you to choose the Virus Warning feature for IDE Hard Disk boot sector protection. If this function is enabled and someone attempts to write data into this area, BIOS will show a warning message on screen and an alarm will beep.

- ◆ Enabled: Activates automatically when the system boots up causing the following warning message to appear when anything attempts to access the boot sector or hard disk partition table:

```
!WARNING!  
Disk boot sector is to be modified  
Type "Y" to accept write or "N" to abort write  
Award Software, Inc.
```

- ◆ Disabled: No warning message will appear when an attempt is made to access the boot sector or hard disk partition table.

Note: This function is available only for DOS and other operating systems that do not trap INT13. For complete protection against viruses, install virus software in your operating system and update the virus definitions regularly.

Many disk diagnostic programs that access the boot sector table can trigger the virus warning message. If you plan to run such a program, we recommend that you disable the virus warning.

CPU L1, L2 and L3 Cache

Cache memory is an additional memory that is much faster than conventional DRAM (system memory). This BIOS feature is used to enable or disable the processor's Level 1, Level 2 and Level 3 cache. Naturally, the default and recommended setting is Enabled.

Note: This field will be available only if your CPU supports this function.

First/Second/Third Boot Device

BIOS attempts to load the operating system from the devices in the sequence selected. The available choices are: Floppy, HDD-0, SCSI, CDROM, HDD-1, HDD-2, HDD-3, USB-FDD, USBZIP, USB-CDROM, USB-HDD, LAN, and Disabled.

Boot Up NumLock Status

Toggle between On or Off to control the state of the NumLock key when the system boot. If On, the numeric keypad is in numeric mode. If Off, the numeric keypad is in cursor control mode.

Gate A20 Option

Gate A20 refers to the way the system addresses memory above 1MB (extended memory). This feature enables you to select whether the chipset or the keyboard controller should control Gate A20. The options are:

- ◆ **Normal:** A pin in the keyboard controller controls Gate A20
- ◆ **Fast** : Let system chipsets control Gate A20. The fast setting improves system speed, particularly with OS/2 and windows.

Security Option

Enables you to select whether the password is required every time the system boots or only when you enter Setup.

- ◆ **System:** The system will not boot and access to Setup will be denied if the correct password is not entered at the prompt.
- ◆ **Setup:** The system will boot, but access to Setup will be denied if the correct password is not entered at setup.

4.9 Advanced Chipset Features

Since the features in this section are related to the chipset in the CPU board and all are optimized, you are not recommended to change the default settings in the setup table, unless you understand the chipset features.

This section allows you to configure the system based on the specific features of the installed chipset. This chipset manage bus speeds and access to system memory resources, such as DRAM and the external cache. It also coordinates communications between the conventional ISA bus and the PCI bus. The default settings have been chosen because they provide the best operating conditions for your system. The only time you might consider making any changes would be if you discovered that data was being lost while using your system.

The first chipset settings deal with CPU access to dynamic random access memory (DRAM). The default timings have been carefully chosen and should only be altered if data is being lost. Such a scenario might well occur if your system has mixed speed DRAM chips installed so that greater delays may be required to preserve the integrity of the data held in the slower memory chips.

Selecting Advanced Chipset Features on the main program screen displays this menu:

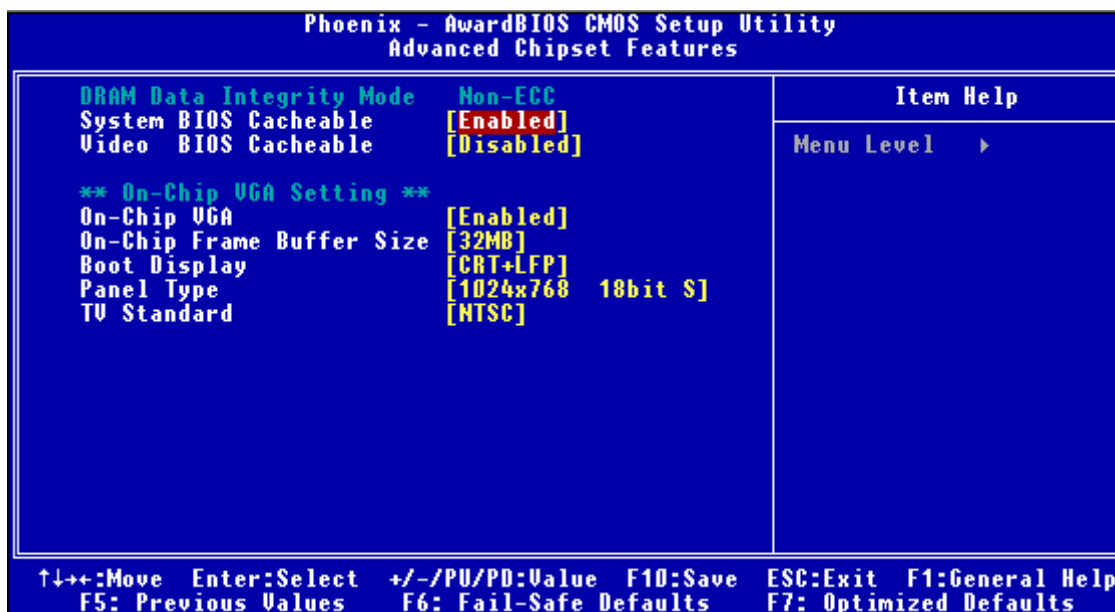

Figure 4-4: BIOS – Advanced Chipset Features

System BIOS cacheable

Selecting Enabled allows caching of the system BIOS ROM at F0000h-FFFFFh, resulting in better system performance. However, if any program writes to this memory area, a system error may result. The available choices are Enabled, Disabled.

Video BIOS Cacheable

Selecting Enabled allows caching of the video BIOS ROM at C0000h, resulting in better video performance. However, if any program writes to this memory area, a system error may result. The choices: Enabled, Disabled.

On-Chip VGA

By default, the On-Chip VGA or chipset-integrated VGA is Enabled.

On-Chip Frame Buffer Size

The On-Chip Frame Buffer Size can be set as 1, 4, 8, 16 or 32MB. This memory is shared with the system memory.

Boot Display

Boot Display determines the display output device where the system boots. The options are Auto, CRT, LFP, and CRT+LFP.

Panel Type

This field allows user to decide the LVDS panel resolution. Please refer to the BIOS for the resolution. After you have made your selections in the Advanced Chipset Features setup, press <ESC> to go back to the main screen. The options are 640x480 18bits, 800x600 18bis, 1024x768 18bits.

TV Standard

This item allows you to designate the type of colored TV standard to be used when a TV receiver is connecting to the TV out port. If a TV receiver is not connected to the XL2, this setting should be disabled. NTSC is for U.S. colored TVs; PAL is for European and other non-U.S. TVs.

4.10 Integrated Peripherals



Figure 4-5: BIOS – Integrated Peripherals

OnChip IDE Device

Select this item to setup the IDE device features. When you select this item, the following menu shows:

USB 2.0 Controller

Select Enabled if your system contains a Universal Serial Bus 2.0 controller and you have USB 2.0 peripherals.

USB Keyboard Support

Select Enabled if your USB controller is enabled and it needs USB keyboard support in legacy (old) OS operating systems such as DOS.

AC97 Audio

Selecting Auto will enable the AC'97 audio if it is detected onboard.

Init Display First

This feature allows you to select whether to boot the system using the onboard AGP graphics card or the PCI graphics card.

Onboard LAN 1/2 H/W Active

Enables and disables the onboard LAN modules.

Onboard FDC Controller

Select Enabled if your system has a floppy disk controller (FDC) installed on the system board and you wish to use it. If you install an add-in FDC or the system has no floppy drive, select Disabled to this field.

Onboard Serial Ports (1, 2, 3, 4)

This feature allows you to manually select the I/O address and IRQ for the first and second serial ports. It is recommended that you leave it as Auto so that the BIOS can select the best settings for it. But if you need a particular I/O port or IRQ that's been taken up by this serial port, you can manually select an alternative I/O port or IRQ for it. You can also disable this serial port if you do not need to use it. Doing so frees up the I/O port and IRQ used by this serial port. Those resources can then be reallocated for other devices to use.

UART Mode Select

Select an operating mode for the serial port.

The choices are: Normal, IrDA, ASKIR.

UR2 Duplex Mode

In an infrared port mode, this field appears. Full-duplex mode permits simultaneous two-direction transmission. Half-duplex mode permits transmission in one direction only at a time. Select the value required by the IR device connected to the IR port.

Onboard Parallel Port

This feature allows you to select the I/O address and IRQ for the onboard parallel port. The default I/O address of 378h and IRQ of 7 should work well in most cases. Unless you have a problem with the parallel port, you should leave it at the default settings. The choices: 378/IRQ7, 278/IRQ5, 3BC/IRQ7, and Disabled.

Parallel Port Mode

Select an operating mode for the onboard parallel (printer) port. There are four options: SPP (Standard Parallel Port), EPP (Enhanced Parallel Port), ECP (Extended Capabilities Port) and ECP+EPP.

ECP Mode Use DMA

When the on-board parallel port is set to ECP mode, the parallel port can use DMA3 or DMA1.

Serial Port 3\4 Use IRQ

This assigns an IRQ to the serial port 3\4.

4.11 Power Management Setup

This option lets you control system power management. The system has various power-saving modes including powering down the hard disk, turning off the video, suspending to RAM, and software power down that allows the system to be automatically resumed by certain events.

The power-saving modes can be controlled by timeouts. If the system is inactive for a time, the timeouts begin counting. If the inactivity continues so that the timeout period elapses, the system enters a power saving mode. If any item in the list of Reload Global Timer Events is enabled, then any activity on that item will reset the timeout counters to zero.

If the system is suspended or has been powered down by software, it can be resumed by a wake up call that is generated by incoming traffic to a modem, a LAN card, a PCI card, or a fixed alarm on the system realtime clock. Selecting Power Management Setup on the main program screen displays this menu:

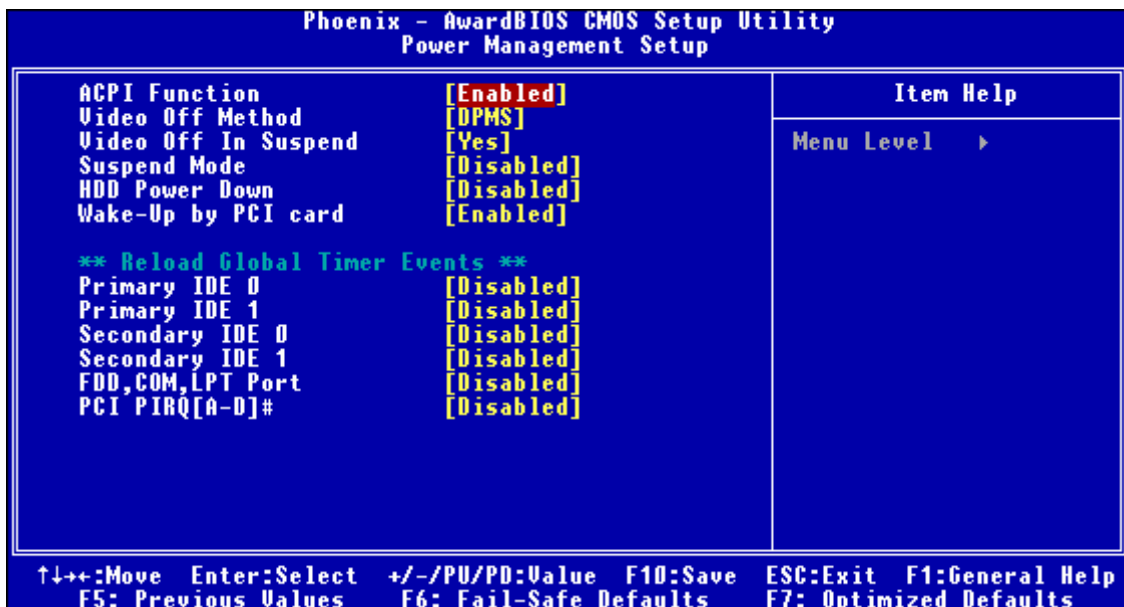

Figure 4-6: BIOS – Power Management Setup

ACPI Function

The ACPI standard (Advanced Configuration and Interface power) allows the operating system directly to check the functions of energy saving and the PnP (Plug and Play) functionality. The ACPI functions are normally activated by the BIOS. The choices are: Enabled and Disabled.

Video Off Method

This determines the manner in which the monitor is blanked. There are three choices:

1. V/H SYNC+Blank: This selection will cause the system to turn off the vertical and horizontal synchronization port and write blanks to the video buffer.
2. Blank Screen: This option only writes blanks to the video buffer.
3. DPMS Support: Select this option if your monitor supports the Display Power Management signaling (DPMS) standard of the Video Electronics Standard to select video power management values.

Video Off In Suspend

This determines the manner in which the monitor is blanked. The choices: Yes, No.

Suspend Mode

After the selected period of system inactivity, all devices except the CPU shut off. The choices are 1~2 min, 2~3 min,.... Up to 1 hour.

HDD Power Down

After the selected period of drive inactivity, the hard disk drive powers down while all other devices remain active.

Wake up by PCI Card

When the system enters a Soft-off mode (Standby power exists but system is not working), it will wake up system when specific signals occurred. The BIOS monitors the system for “activity” to determine when to enable power management.

If you enable this feature, the computer specifies that any signal noticed on the PCI (Peripheral Component Interconnect) bus channel must make go out from the hibernation state. The choices: Enabled, Disabled.

Reload Global Timer Events

Primary/Secondary IDE 0/1

FDD, COM, LPT Port

PCI PIRQ [A-D]#

The events are I/O events whose occurrence can prevent the system from entering a power saving mode or can awaken the system from such a mode. In effect, the system remains alert for anything, which occurs to a device, which is configured as Enabled, even when the system is in a power down mode. The choices are Enabled, and Disabled.

After you have made your selections in the Power Management setup, press the <ESC> key to go back to the main program screen.

4.12 PnP/PCI Configurations

This section describes configuring the PCI bus system. Peripheral Component Interface, is a system which allows I/O devices to operate at speeds nearing the speed the CPU itself uses when communicating with its own special components. This section covers some very technical items and it is strongly recommended that only experienced users should make any changes to the default settings.

Selecting PnP/PCI Configurations on the main program screen displays this menu:

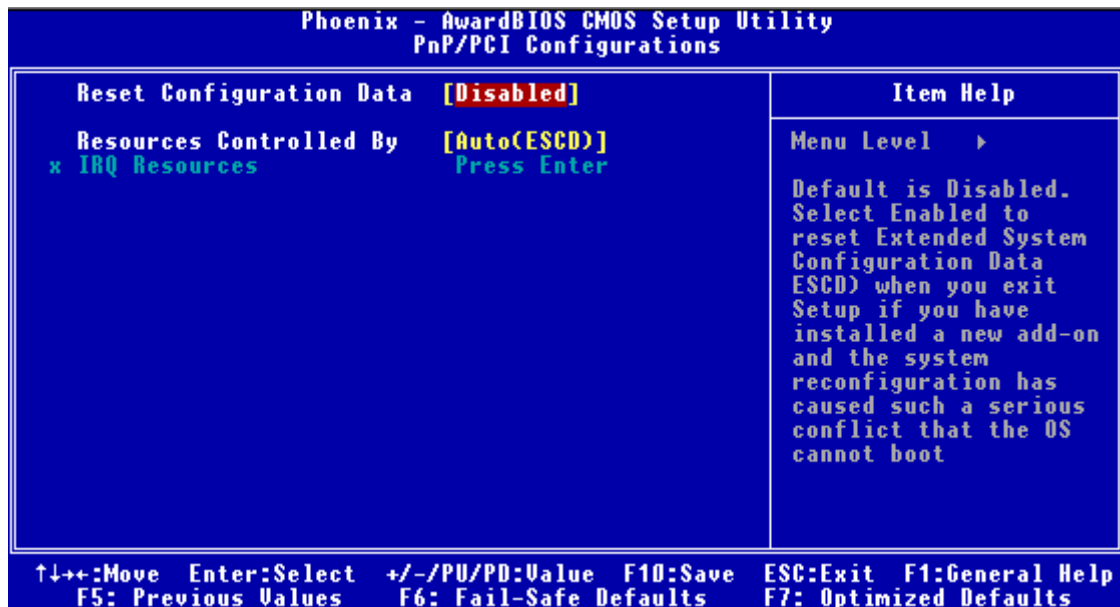

Figure 4-7: BIOS – PnP/PCI Configurations

Reset Configuration Data

Normally, you leave this field Disabled, Select Enabled to reset Extended System Configuration Data (ESCD) when you exit Setup if you have installed a new add-on Card and the system reconfiguration has caused such a serious conflict that the operating system can not boot. The choices are Enabled and Disabled.

Resources Controlled By

The Award Plug and Play BIOS has the capacity to automatically configure all of the boot and Plug and Play compatible devices. However, this capability means absolutely nothing unless you are using a Plug and Play operating system such as going into each of the submenus that follows this field. The choices are Auto (ESCD), Manual.

4.13 PC Health Status

When main boards support hardware monitoring, this item lets you monitor the parameters for critical voltages, critical temperatures, and fan speeds. These are the read only items.

After you have read the PC Health Status, press the <ESC> key to go back to the main program screen.

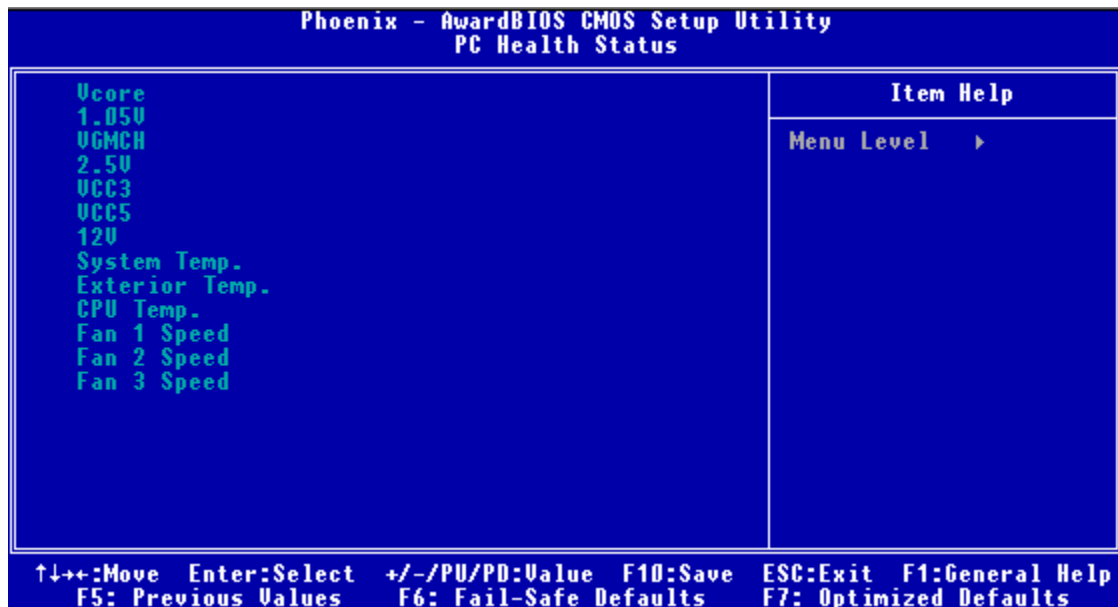

Figure 4-8: PC Health Status

4.14 Load Fail-Safe Defaults

This option opens a dialog box that lets you install fail-safe defaults for all appropriate items in the whole setup utility. Press the <Y> key and then <Enter> to install the defaults. Press the <N> key and then <Enter> to not install the defaults.

Use this option if you have changed your system and it does not operate correctly or does not power up.

4.15 Load Optimized Defaults

This option opens a dialog box that lets you install optimized defaults for all appropriate items in the whole setup utility. Press the <Y> key and then <Enter> to install the defaults. Press the <N> key and then <Enter> to not install the defaults. The optimized defaults place demands on the system that may be greater than the performance level of the components, such as the CPU and the memory. You can cause fatal errors or instability if you install the optimized defaults when your hardware does not support them. If you only want to install setup defaults for a specific option, select and display that option, and then press the <F7> key.

4.16 Set Password

The User Password utility sets the password. The main board is shipped with the password disabled. If you want to change the password, you must first enter the current password, then at the prompt enter your new password. The password is case sensitive. You can use up to eight alphanumeric characters. Press <Enter> after entering the password. At the next prompt, confirm the new password by retyping it and pressing <Enter> again.

To disable the password dialog box appears. A message appears confirming that the password has been disabled. If you have set supervisor and user Password, only the supervisor password allows you to enter the BIOS setup program.

Note: If you forget your password, the only way to solve this problem is to discharge the CMOS memory by turning power off and placing a shunt (jumper cap) on jumper JP2 to short pin 2 and pin 3 for five seconds, then putting the shunt back to pin 1 and pin 2 of JP2.

4.17 Save & Exit Setup

Selecting this option and pressing <Enter> will save the new setting information in the CMOS memory and continue with the booting process.

4.18 Exit Without Saving

Selecting this option and pressing <Enter> will exit the Setup utility without recording any new values or changing old ones.

Appendix A

Watchdog Timer

The EBC573 features a watchdog timer that reset the CPU or generates an interrupt if the processor stops operating for any reason. This feature ensures system reliability in industrial standalone or unmanned environments.

A.1 Watchdog Timer Working Procedure

The Watchdog Timer (WDT) is a special hardware device that monitors the computer system during normal operation. The WDT has a clock circuit that times down from a set number to zero. If a monitored item occurs before the timer reaches zero, the WDT resets and counts down again. If for some reason the monitored item doesn't occur before the timer reaches zero, the WDT performs an action, such as a diagnostic operation (rebooting the computer) or generate an NMI.

You must enter timer values into the WDT Configuration Register (Write the control value to the Configuration Port), and clear (read the Configuration Port).

WDT Configuration port	I/O port 2E0h	Read/Writable, default at 2E0h
Watchdog Timer	Disabled	Disable WDT functions (Default setting)
	Enabled	Enable WDT functions controlled by WDT time out active for and WDT Time Out Active Time
WDT Time out active for	Reset Output	Reset system when WDT time out
	NMI Output	Generate NMI when WDT time out
	WDT Notice Output	1. Located at J8 pin No. 6 2. Normal work output low level 3. Output high level when WDT time-out, read or write WDT configuration port return to normal work (output low level)
WDT Time Out Active Time	1 sec/min 2 sec/min 4 sec/min 8 sec/min 16 sec/min 32 sec/min 64 sec/min 128 sec/min	WDT time out occurs after the selected time level

Table A-1: Watchdog Timer Character and Function

A.2 Watchdog Timer Control Register

The Watchdog Timer Control Register controls the EDT working mode. Write the value to the WDT Configuration Port. The following table describes the Control Register bit definition.

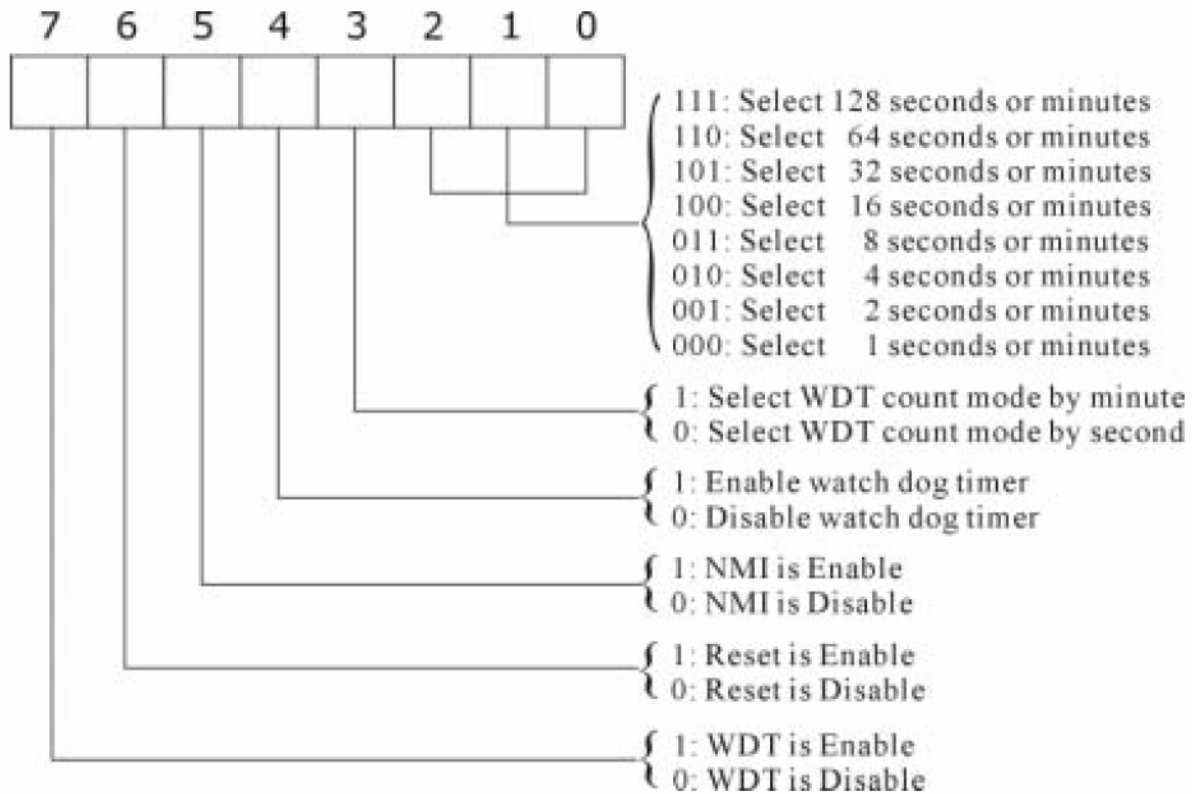

Table A-2: Control Register Bit Definition

A.3 Watchdog Timer Programming Procedure

Power on or reset the system

The initial value of WDT Control Register (D4~D0) is zero, when power is on or reset the system. The following shows the initial value of WDT (00000000b):

Bit	Value	Meaning
7	0	Disable WDT
6	0	Reset output is disable
5	0	NMI output is disable
4	0	WDT Notice output is disable
3	0	Select WDT count mode by second
2, 0,1	000	Select time-out occurs after 1 second/minute

Table A-3: WDT Control Register Initial Value

Clear the WDT

The WDT counter internal cannot be longer than the preset time; otherwise, the WDT generates a NMI (Non Maskable Interrupt) or sends a reset signal to the system.

Note: Before running WDT, clear the WDT to make sure the initial value is zero before enabling the WDT.

WDT Control Register (Write to WDT configuration port)

Note: This register writes to the WDT configuration port.

You can set the WDT Control Register to control the WDT working mode.

Follow below instructions to set the initial value of the WDT working mode.

1. Select the WDT time out occurs time

Time-out intervals decide by values of bit 2, bit 1, bit 0 in I/O port 2E0h minute or second decide by values of bit 3 in I/O port 2E0h

2. Enable or Disable WDT Notice Output decide by bit 4 value in I/O port 2E0h
3. Enable or Disable NMI Output decide by bit 5 value in I/O port 2E0h
4. Enable or Disable Reset Output decide by bit 6 value in I/O port 2E0h
5. Enable or Disable the WDT decide by bit 7 value in I/O port 2E0h

After finishing the above settings, you must output the Control Register's value to the WDT Configuration Port. Then WDT will start according to the above settings.

Note: Build a mechanism in the program to continue to read the WDT Configuration Port for clearing WDT before time out.

Appendix B

GPI/O Programming

B.1 GPI/O Programming

GPI/O (General Purpose Input/Output) pins are provided for custom system design. This appendix provides definitions and its default setting for the ten GPI/O pins in the EBC573 series. The pin definition is shown in the following table:

Pin No.	GPI/O mode	PowerOn Default	Address	Pin No.	GPI/O mode	PowerOn Default	Address
1	GPI	Read High	801H (0)	2	GPO	High	801H (4)
3	GPI	Read High	801H (1)	4	GPO	High	801H (5)
5	GPI	Read High	801H (2)	6	GPO	High	801H (6)
7	GPI	Read High	801H (3)	8	GPO	High	801H (7)
9	VCC	-	-	10	GND	-	-

Table C-1: J15 – GPI/O Connector

Read the GPI Pin (1/3/5/7) status form I/O port 801H bit (0/1/2/3).

The bit is Set/Clear indicated High/Low

Control the GPO pin (2/3/6/8) level from I/O port 801H bit (4/5/6/7).

The bit is Set/Clear indicated output High/Low

Note: All of these GPIO pins are 8mA digital open-drain buffer and internal pull-up.