

ENDURA 50 (international) PARTS DIAGRAM

for use with "N" serial numbers

2-year warranty

12-volt 42 amps

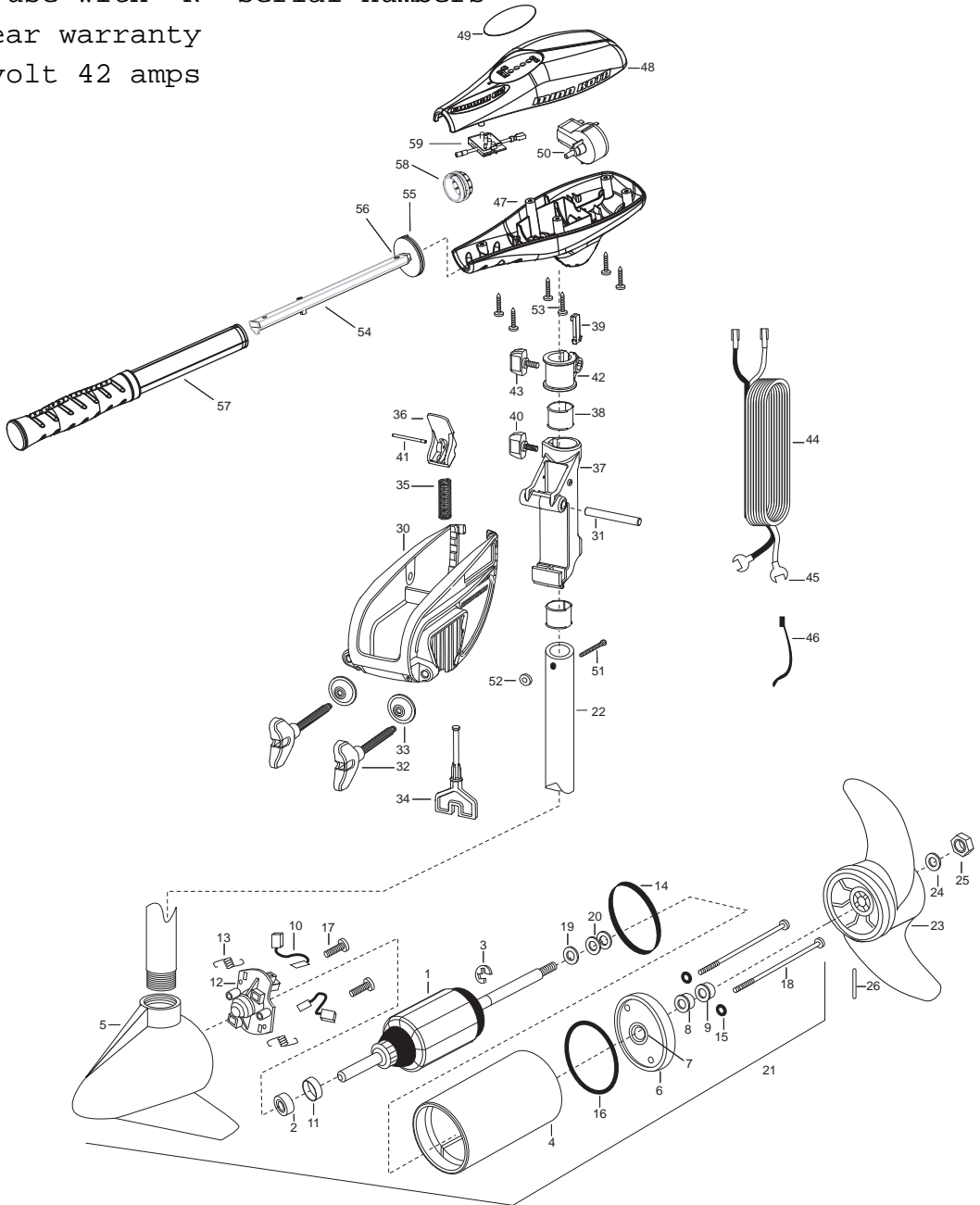

ENDURA 50 (36" & 42") PARTS LIST₇

<u>Item</u>	<u>Part Number</u>	<u>Description</u>
1	2-100-121	ARMATURE ASSEMBLY 12v 3.62
2	140-010	BEARING- BALL
3	788-015	RETAINING RING
4	2-200-101	CENTER HOUSING ASSEMBLY-
5	2-300-196	BRUSH END HOUSING ASSEMBLY 3.62 SPCO 36"
	2-300-195	BRUSH END HOUSING ASSEMBLY 3.62 SPCO 42"
6	2-400-101	PLAIN END HOUSING ASSEMBLY
7	144-049	BEARING- FLANGE, SERVICE ONLY
8	880-003	SEAL
9	880-006	SEAL WITH SHIELD
10	188-036	BRUSH ASSEMBLY [2.EA]
11	725-050	BRUSH RETENTION- PAPER TUBE
12	738-036	BRUSH PLATE WITH HOLDER
13	975-040	SPRING-TORSION [2.EA]
14	337-036	GASKET
15	701-008	O-RING [2.EA]
16	701-081	O-RING
17	830-007	SCREW- # 8-32 [2.EA]
18	830-042	THRU BOLT 10-32X8.83 [2.EA]
19	990-067	WASHER- STEEL THRUST
20	990-070	WASHER- NYLATRON [2.EA]
21	2097035	MOTOR ASSEMBLY 12V 3.62 5SPC FW 36"
	2097036	MOTOR ASSEMBLY 12V 3.62 5SPC FW 42"
22	2032046	TUBE COMPOSITE 36"
	2032047	TUBE COMPOSITE 42"
■	1378170	PROPELLER KIT
23	2091170	PROP, POWER 3-5/8"
24	2151726	WASHER- 5/16 STD SS
25	2053101	NUT- NYLOC 5/16
26	2092600	PIN-DRIVE
■	2771818	BRACKET & HINGE ASSEMBLY (INCLUDES 30-41)
■	2771910	BRACKET ASSEMBLY (INCLUDES 30, 32, 33)
*30	2061910	BRACKET
31	2060510	PIN-HINGE

PARTS LIST (cont.)

<u>Item</u>	<u>Part Number</u>	<u>Description</u>
■	2881300	SCREW-CLAMP, WASHER, RETAINER KIT [2.EA]
*32	2061300	SCREW-CLAMP [2.EA]
*33	2011710	WASHER-CLAMP [2.EA]
34	2063605	T-BAR, PLASTIC
35	2062706	SPRING- T-BAR
36	2067201	LEVER- TILT BLACK
37	2061810	HINGE-PLASTIC
38	2037301	BUSHING-HING [2.EA]
39	2062800	TENSION BLOCK-SNAP IN
40	2011385	SCREW, TENSION/KNOB
41	2060515	PIN, TILT LEVER
42	2061520	COLLAR-DEPTH
43	2011365	SCREW-COLLAR/NEW KNOB
44	2020631	LEADWIRE (10 GA) FLAG/PIGGYBACK
45	2020702	SPADE TERMINAL 10GA. [2.EA]
46	2026300	TIE WRAP [2.EA]
47	2062515	CONTROL BOX
48	2060215	CONTROL BOX COVER
49	2065724	DECAL COVER ENDURA C2 50 BATTERY METER
50	2064028	SWITCH-FWD/REV 5 SP
51	2033400	SCREW-10-24 X 1-3/4
52	2013110	NUT-10-24 HEX
53	2012100	SCREW-8-18 X 5/8 [6.EA]
54	2990919	INNER HANDLE ASSEMBLY
55	2060405	PIVOT, HANDLE
56	2012102	SCREW
57	2990928	OUTER HANDLE ASSEMBLY
58	2060009	FRONT BEARING
59	2074070	BATTERY METER 12V
■	2888460	O-RING, GASKET SEAL KIT

* This item is part of an assembly. This item cannot be sold separately due to machining and/or assembly that is required.

WIRING DIAGRAM

