



**NEXCOM International Co., Ltd.**

**IoT Automation Solutions Business Group**

**Industrial Fanless Computer**

**NISE 3900 Series**

User Manual

# CONTENTS

## Preface

Copyright .....	iv
Disclaimer .....	iv
Acknowledgements .....	iv
Regulatory Compliance Statements.....	iv
Declaration of Conformity.....	iv
RoHS Compliance .....	v
Warranty and RMA .....	vi
Safety Information .....	viii
Installation Recommendations.....	viii
Safety Precautions.....	ix
Technical Support and Assistance.....	x
Conventions Used in this Manual.....	x
Global Service Contact Information.....	xi
Package Contents.....	xiii
Ordering Information.....	xiv

## Chapter 1: Product Introduction

NISE 3900E Overview.....	1
Key Features.....	1
NISE 3900E Hardware Specifications .....	2
NISE 3900E2/P2/P2E Overview .....	4
Key Features.....	4
NISE 3900E2/P2/P2E Hardware Specifications.....	5
NISE 3900E-H310 Overview .....	7

Key Features.....	7
NISE 3900E-H310 Hardware Specifications.....	8
NISE 3900R Overview.....	10
Key Features.....	10
NISE 3900R Hardware Specifications .....	11
Knowing Your NISE 3900 Series .....	13
NISE 3900E & NISE 3900R Front Panel .....	13
NISE 3900E Rear Panel.....	14
NISE 3900R Rear Panel .....	14
NISE 3900E-H310 Front Panel.....	15
NISE 3900E-H310 Rear Panel.....	16
NISE 3900E2/P2/P2E Front Panel .....	17
NISE 3900E2/P2/P2E Rear Panel .....	18
Mechanical Dimensions.....	19

## Chapter 2: Jumpers and Connectors

Before You Begin .....	23
Precautions .....	23
Jumper Settings .....	24
Locations of the Jumpers and Connectors for the NISE 3900 Series.....	25
Jumpers and DIP Switch Settings.....	27
AT/ATX Power Select .....	27
Clear CMOS .....	27
CPU CFG Strap Pin .....	28
Connector Pin Definitions .....	29
External I/O Interfaces - Front Panel .....	29

- Power Button..... 29
- LED Indicators ..... 29
- DisplayPort..... 30
- SIM Card Socket ..... 30
- USB 2.0 Ports (N/A on NISE 3900E-H310)..... 31
- USB 2.0 Ports ..... 31
- External I/O Interfaces - Rear Panel..... 32
  - 9V - 30V DC Power Input..... 32
  - Remote Power On/Off & S3 Connector ..... 32
  - LAN1 and USB 3.1 Ports (Not available on NISE 3900E-H310)..... 33
  - LAN2 and USB 3.1 Ports..... 34
  - LAN3 and USB 3.1 Ports..... 35
  - DVI-D Connector..... 36
  - HDMI ..... 36
- Internal Connectors..... 37
  - BIOS Pin Header ..... 37
  - SATA Connectors ..... 37
  - SATA Power Connectors..... 38
  - GPIO Pin Header ..... 38
  - System Reset..... 39
  - Port 80 Connector ..... 39
  - COM1 Connector (Full RS232/422/485) ..... 40
  - COM2 Connector (Full RS232/422/485) ..... 40
  - COM3 Connector (Full RS232) ..... 41
  - COM4 Connector (Full RS232) ..... 41
  - Speaker-out Header ..... 42
  - Mic-in Header ..... 42
  - Line-out Header ..... 43
  - Line-in Header..... 43
  - RTC Battery Connector..... 44
  - SMBus Header ..... 44
  - LED Pin Header ..... 45

- System Fan Box Header ..... 45
- Mini-PCIe Connector (PCIe/GSM/USB 2.0) ..... 46
- NGFF M.2 B-Key Connector (USB 3.0/USB 2.0) ..... 47
- NGFF M.2 M-Key Connector (SATA/PCIe x1)..... 48
- PCIe x16 Slot..... 49

### Chapter 3: System Setup

- Removing the Top Cover ..... 51
- Removing the Bottom Cover ..... 53
- Installing a CPU..... 54
- Installing a Mini-PCIe Module..... 57
- Installing an M.2 Module (Internal)..... 59
- Installing a SO-DIMM Memory Module ..... 61
- Installing a SIM Card ..... 62
- Installing an M.2 Card (External) ..... 63
- Installing an Internal SATA Storage Drive (NISE 3900E/P2/P2E/E2/H310) .. 65
- Installing an External SATA Storage Drive (NISE 3900R)..... 67
- Wallmount Brackets..... 69

### Chapter 4: BIOS Setup

- About BIOS Setup ..... 70
- When to Configure the BIOS..... 70
- Default Configuration ..... 71
- Entering Setup ..... 71
- Legends ..... 71
- BIOS Setup Utility..... 73
  - Main ..... 73
  - Advanced ..... 74
  - Chipset..... 80
  - Security ..... 83
  - Boot..... 84
  - Save & Exit ..... 85

# PREFACE

## Copyright

This publication, including all photographs, illustrations and software, is protected under international copyright laws, with all rights reserved. No part of this manual may be reproduced, copied, translated or transmitted in any form or by any means without the prior written consent from NEXCOM International Co., Ltd.

## Disclaimer

The information in this document is subject to change without prior notice and does not represent commitment from NEXCOM International Co., Ltd. However, users may update their knowledge of any product in use by constantly checking its manual posted on our website: <http://www.nexcom.com>. NEXCOM shall not be liable for direct, indirect, special, incidental, or consequential damages arising out of the use of any product, nor for any infringements upon the rights of third parties, which may result from such use. Any implied warranties of merchantability or fitness for any particular purpose is also disclaimed.

## Acknowledgements

NISE 3900E, NISE 3900E2, NISE 3900P2, NISE 3900P2E, NISE 3900E-H310 and NISE 3900R are trademarks of NEXCOM International Co., Ltd. All other product names mentioned herein are registered trademarks of their respective owners.

## Regulatory Compliance Statements

This section provides the FCC compliance statement for Class A devices and describes how to keep the system CE compliant.

## Declaration of Conformity

### FCC

This equipment has been tested and verified to comply with the limits for a Class A digital device, pursuant to Part 15 of FCC Rules. These limits are designed to provide reasonable protection against harmful interference when the equipment is operated in a commercial environment. This equipment generates, uses, and can radiate radio frequency energy and, if not installed and used in accordance with the instructions, may cause harmful interference to radio communications. Operation of this equipment in a residential area (domestic environment) is likely to cause harmful interference, in which case the user will be required to correct the interference (take adequate measures) at their own expense.

### CE

The product(s) described in this manual complies with all applicable European Union (CE) directives if it has a CE marking. For computer systems to remain CE compliant, only CE-compliant parts may be used. Maintaining CE compliance also requires proper cable and cabling techniques.

## RoHS Compliance



### **NEXCOM RoHS Environmental Policy and Status Update**

NEXCOM is a global citizen for building the digital infrastructure. We are committed to providing green products and services, which are compliant with European Union RoHS (Restriction on Use of Hazardous Substance in Electronic Equipment) directive 2011/65/EU, to be your trusted green partner and to protect our environment.

RoHS restricts the use of Lead (Pb) < 0.1% or 1,000ppm, Mercury (Hg) < 0.1% or 1,000ppm, Cadmium (Cd) < 0.01% or 100ppm, Hexavalent Chromium (Cr6+) < 0.1% or 1,000ppm, Polybrominated biphenyls (PBB) < 0.1% or 1,000ppm, and Polybrominated diphenyl Ethers (PBDE) < 0.1% or 1,000ppm.

In order to meet the RoHS compliant directives, NEXCOM has established an engineering and manufacturing task force to implement the introduction of green products. The task force will ensure that we follow the standard NEXCOM development procedure and that all the new RoHS components and new manufacturing processes maintain the highest industry quality levels for which NEXCOM are renowned.

The model selection criteria will be based on market demand. Vendors and suppliers will ensure that all designed components will be RoHS compliant.

### **How to recognize NEXCOM RoHS Products?**

For existing products where there are non-RoHS and RoHS versions, the suffix "(LF)" will be added to the compliant product name.

All new product models launched after January 2013 will be RoHS compliant. They will use the usual NEXCOM naming convention.

## Warranty and RMA

### NEXCOM Warranty Period

NEXCOM manufactures products that are new or equivalent to new in accordance with industry standard. NEXCOM warrants that products will be free from defect in material and workmanship for 2 years, beginning on the date of invoice by NEXCOM.

### NEXCOM Return Merchandise Authorization (RMA)

- Customers shall enclose the “NEXCOM RMA Service Form” with the returned packages.
- Customers must collect all the information about the problems encountered and note anything abnormal or, print out any on-screen messages, and describe the problems on the “NEXCOM RMA Service Form” for the RMA number apply process.
- Customers can send back the faulty products with or without accessories (manuals, cable, etc.) and any components from the card, such as CPU and RAM. If the components were suspected as part of the problems, please note clearly which components are included. Otherwise, NEXCOM is not responsible for the devices/parts.
- Customers are responsible for the safe packaging of defective products, making sure it is durable enough to be resistant against further damage and deterioration during transportation. In case of damages occurred during transportation, the repair is treated as “Out of Warranty.”
- Any products returned by NEXCOM to other locations besides the customers’ site will bear an extra charge and will be billed to the customer.

### Repair Service Charges for Out-of-Warranty Products

NEXCOM will charge for out-of-warranty products in two categories, one is basic diagnostic fee and another is component (product) fee.

#### System Level

- Component fee: NEXCOM will only charge for main components such as SMD chip, BGA chip, etc. Passive components will be repaired for free, ex: resistor, capacitor.
- Items will be replaced with NEXCOM products if the original one cannot be repaired. Ex: motherboard, power supply, etc.
- Replace with 3rd party products if needed.
- If RMA goods can not be repaired, NEXCOM will return it to the customer without any charge.

#### Board Level

- Component fee: NEXCOM will only charge for main components, such as SMD chip, BGA chip, etc. Passive components will be repaired for free, ex: resistors, capacitors.
- If RMA goods can not be repaired, NEXCOM will return it to the customer without any charge.

## Warnings

Read and adhere to all warnings, cautions, and notices in this guide and the documentation supplied with the chassis, power supply, and accessory modules. If the instructions for the chassis and power supply are inconsistent with these instructions or the instructions for accessory modules, contact the supplier to find out how you can ensure that your computer meets safety and regulatory requirements.

## Cautions

Electrostatic discharge (ESD) can damage system components. Do the described procedures only at an ESD workstation. If no such station is available, you can provide some ESD protection by wearing an antistatic wrist strap and attaching it to a metal part of the computer chassis.

## Safety Information

Before installing and using the device, note the following precautions:

- Read all instructions carefully.
- Do not place the unit on an unstable surface, cart, or stand.
- Follow all warnings and cautions in this manual.
- When replacing parts, ensure that your service technician uses parts specified by the manufacturer.
- Avoid using the system near water, in direct sunlight, or near a heating device.
- The load of the system unit does not solely rely for support from the rackmounts located on the sides. Firm support from the bottom is highly necessary in order to provide balance stability.
- The computer is provided with a battery-powered real-time clock circuit. There is a danger of explosion if battery is incorrectly replaced. Replace only with the same or equivalent type recommended by the manufacturer. Discard used batteries according to the manufacturer's instructions.



Danger of explosion if battery is incorrectly replaced. Replace with the same or equivalent type recommended by the manufacturer. Discard used batteries according to the manufacturer's instructions.

## Installation Recommendations

Ensure you have a stable, clean working environment. Dust and dirt can get into components and cause a malfunction. Use containers to keep small components separated.

Adequate lighting and proper tools can prevent you from accidentally damaging the internal components. Most of the procedures that follow require only a few simple tools, including the following:

- A Philips screwdriver
- A flat-tipped screwdriver
- A grounding strap
- An anti-static pad

Using your fingers can disconnect most of the connections. It is recommended that you do not use needle-nose pliers to disconnect connections as these can damage the soft metal or plastic parts of the connectors.



## Safety Precautions

1. Read these safety instructions carefully.
2. Keep this User Manual for later reference.
3. Disconnect this equipment from any AC outlet before cleaning. Use a damp cloth. Do not use liquid or spray detergents for cleaning.
4. For plug-in equipment, the power outlet socket must be located near the equipment and must be easily accessible.
5. Keep this equipment away from humidity.
6. Put this equipment on a stable surface during installation. Dropping it or letting it fall may cause damage.
7. The openings on the enclosure are for air convection to protect the equipment from overheating. DO NOT COVER THE OPENINGS.
8. Make sure the voltage of the power source is correct before connecting the equipment to the power outlet.
9. Place the power cord in a way so that people will not step on it. Do not place anything on top of the power cord. Use a power cord that has been approved for use with the product and that it matches the voltage and current marked on the product's electrical range label. The voltage and current rating of the cord must be greater than the voltage and current rating marked on the product.
10. All cautions and warnings on the equipment should be noted.
11. If the equipment is not used for a long time, disconnect it from the power source to avoid damage by transient overvoltage.
12. Never pour any liquid into an opening. This may cause fire or electrical shock.
13. Never open the equipment. For safety reasons, the equipment should be opened only by qualified service personnel.
14. If one of the following situations arises, get the equipment checked by service personnel:
  - a. The power cord or plug is damaged.
  - b. Liquid has penetrated into the equipment.
  - c. The equipment has been exposed to moisture.
  - d. The equipment does not work well, or you cannot get it to work according to the user's manual.
  - e. The equipment has been dropped and damaged.
  - f. The equipment has obvious signs of breakage.
15. Do not place heavy objects on the equipment.
16. The equipment is intended to be supplied by DC mains, input voltage tolerance should be within 9-30Vdc and without PE connection.
17. **CAUTION:** DANGER OF EXPLOSION IF BATTERY IS INCORRECTLY REPLACED. REPLACE ONLY WITH THE SAME OR EQUIVALENT TYPE RECOMMENDED BY THE MANUFACTURER. DISCARD USED BATTERIES ACCORDING TO THE MANUFACTURER'S INSTRUCTIONS.
18. Direct contact to metal enclosure should be less than 1 second time.

## Technical Support and Assistance

1. For the most updated information of NEXCOM products, visit NEXCOM's website at [www.nexcom.com](http://www.nexcom.com).
2. For technical issues that require contacting our technical support team or sales representative, please have the following information ready before calling:
  - Product name and serial number
  - Detailed information of the peripheral devices
  - Detailed information of the installed software (operating system, version, application software, etc.)
  - A complete description of the problem
  - The exact wordings of the error messages

### Warning!

1. Handling the unit: carry the unit with both hands and handle it with care.
2. Maintenance: to keep the unit clean, use only approved cleaning products or clean with a dry cloth.
3. CompactFlash: Turn off the unit's power before inserting or removing a CompactFlash storage card.

## Conventions Used in this Manual



### Warning:

Information about certain situations, which if not observed, can cause personal injury. This will prevent injury to yourself when performing a task.



### Caution:

Information to avoid damaging components or losing data.



### Note:

Provides additional information to complete a task easily.



**Safety Warning:** This equipment is intended for installation in a Restricted Access Location only.

## Global Service Contact Information

### Headquarters

#### **NEXCOM International Co., Ltd.**

9F, No. 920, Chung-Cheng Rd.,  
ZhongHe District, New Taipei City, 23586,  
Taiwan, R.O.C.

Tel: +886-2-8226-7786

Fax: +886-2-8226-7782

[www.nexcom.com](http://www.nexcom.com)

### Asia

#### Taiwan

#### **NexAIoT Co., Ltd.**

#### **Taipei Office**

13F, No.920, Chung-Cheng Rd.,  
ZhongHe District,  
New Taipei City, 23586, Taiwan, R.O.C.

Tel: +886-2-8226-7796

Fax: +886-2-8226-7792

Email: [sales@nexcom.com.tw](mailto:sales@nexcom.com.tw)

[www.nexcom.com.tw](http://www.nexcom.com.tw)

#### **NexAIoT Co., Ltd.**

#### **Taichung Office**

16F, No.250, Sec. 2, Chongde Rd.,  
Beitun Dist.,

Taichung City 406, R.O.C.

Tel: +886-4-2249-1179

Fax: +886-4-2249-1172

Email: [sales@nexcom.com.tw](mailto:sales@nexcom.com.tw)

[www.nexcom.com.tw](http://www.nexcom.com.tw)

#### **NexCOBOT Taiwan Co., Ltd.**

13F, No.916, Chung-Cheng Rd.,  
ZhongHe District,  
New Taipei City, 23586, Taiwan, R.O.C.

Tel: +886-2-8226-7796

Fax: +886-2-8226-7792

Email: [sales@nexcom.com.tw](mailto:sales@nexcom.com.tw)

[www.nexcom.com.tw](http://www.nexcom.com.tw)

#### **GreenBase Technology Corp.**

13F, No.922, Chung-Cheng Rd.,  
Zhonghe Dist.,  
New Taipei City, 23586, Taiwan, R.O.C.

Tel: +886-2-8226-7786

Fax: +886-2-8226-7900

Email: [sales@nexcom.com.tw](mailto:sales@nexcom.com.tw)

[www.nexcom.com.tw](http://www.nexcom.com.tw)

### China

#### **NEXSEC Incorporated**

Floor 5, No.4, No.7 fengxian middle Rd.,  
(Beike Industrial Park), Haidian District,  
Beijing, 100094, China

Tel: +86-10-5704-2680

Fax: +86-10-5704-2681

Email: [sales@nexcom.cn](mailto:sales@nexcom.cn)

[www.nexcom.cn](http://www.nexcom.cn)

**NEXCOM Shanghai**

Room 603/604, Huiyinmingzun Plaza Bldg., 1,  
No. 609, Yunlin East Rd.,  
Shanghai, 200062, China  
Tel: +86-21-5278-5868  
Fax: +86-21-3251-6358  
Email: sales@nexcom.cn  
www.nexcom.cn

**NEXCOM Surveillance Technology Corp.**

Floor 5, Building C, ZhenHan Industrial Zone,  
GanKeng Community, Buji Street,  
LongGang District,  
ShenZhen, 518112, China  
Tel: +86-755-8364-7768  
Fax: +86-755-8364-7738  
Email: steveyang@nexcom.com.tw  
www.nexcom.cn

**NEXCOM United System Service**

Room 603/604, Huiyinmingzun Plaza Bldg. 1,  
No. 609, Yunlin East Rd.,  
Shanghai, 200062, China  
Tel: +86-21-5278-5868  
Fax: +86-21-3251-6358  
Email: renwang@nexcom.com.tw  
www.nexcom.cn

**NEXGOL**

1st Floor, Building B4, Electronic 2nd Area,  
(Phoenix Lake Industrial Park), Yongchuan Dist.,  
Chongqing City, 402160, China  
Tel: +86-23-4960-9080  
Fax: +86-23-4966-5855  
Email: sales@nexcobot.com  
www.nexgol.com/NexGoL

**Beijing NexGemo Technology Co.,Ltd.**

5th Floor, Gemotech Building, No.1, Development Rd.,  
Changping International Information Industry Base,  
Changping District,  
Beijing, 102206, China  
Tel: +86-10-8190-9399  
Fax: +86-10-8190-9456

**Japan****NEXCOM Japan**

9F, Tamachi Hara Bldg.,  
4-11-5, Shiba Minato-ku,  
Tokyo, 108-0014, Japan  
Tel: +81-3-5419-7830  
Fax: +81-3-5419-7832  
Email: sales@nexcom-jp.com  
www.nexcom-jp.com

**Europe****United Kingdom  
NEXCOM EUROPE**

10 Vincent Avenue,  
Crownhill Business Centre,  
Milton Keynes, Buckinghamshire  
MK8 0AB, United Kingdom  
Tel: +44-1908-267121  
Fax: +44-1908-262042  
Email: sales.uk@nexcom.eu  
www.nexcom.eu

**America  
USA****NEXCOM USA**

2883 Bayview Drive,  
Fremont CA 94538, USA  
Tel: +1-510-656-2248  
Fax: +1-510-656-2158  
Email: sales@nexcom.com  
www.nexcom.com

## Package Contents

Before continuing, verify that the NISE 3900 series package that you received is complete. Your package should have all the items listed in the following table.

Item	Part Number	Description	Qty		
			NISE 3900E NISE 3900E-H310	NISE 3900E2 NISE 3900P2 NISE 3900P2E	NISE 3900R
1	4NCPF00310X00	Terminal Blocks 3P Phoenix Contact:1803581 3.81mm Female DIP Green	1	1	1
2	4NCPM00302X00	Terminal Blocks 3P Phoenix Contact:1777992 5.08mm Male DIP Green	1	1	1
3	50311F0100X00	Round Head Screw w/Spring+Flat Washer Long Fei:P3x6L P3x6 iso/SW6x0.5 NI	3	3	1
4	50311F0143X00	Flat Head Screw Long Fei:F#6-32x8 F#6-32x8 TROX 10 NI+ Nylok	1	1	1
5	50311F0213X00	Flat Head Screw Long Fei:f3x4iso+Nylok NIGP F3x4 NI Nylok	4	4	8
6	50311F0295X00	Flat Head Screw Long Fei:f2x4 Nylok NIGP F2x4 NIGP Nylok	1	1	1
7	50311F0315X00	Round Head Screw Long Fei:p6#32T T10 Nylok P6#32T Outer Teeth Washer T10 Nylok	1	1	1
8	50311F0330X00	Round Head Screw Long Fei:p2x3 Iso+Nylon P2x3 NI Nylok	2	2	3
9	50311P0001X00	Price For Plastic Screw Hs6-75P 75Mm	1	2	0
10	50322P0002X00	Plastic Nut Gin Lian:m6hw 10Mmx6mm	1	2	0
11	5060200427X00	Thermal Pad E-LIN 24x24x0.5mm PTUT	1	1	1
12	5060600171X00	2.5 HDD Mylar E-LIN 96.2x70x0.1mm	1	1	0
13	5060900226X00	Mini-Pcie Bracket CHYUAN-JYH 29x30x2.1mm SPCC t=1.0mm NI	1	1	1
14	60177A0739X00	NISE 3900 Series Quick Reference Guide VER:A Kramer Size:A4	1	1	1
15	602DCD1628X00	NISE 3900 Series DVD Driver VER:1.0 JCL	1	1	1

## Ordering Information

The following information below provides ordering information for the NISE 3900 series.

- **Barebone**

**NISE 3900E System (P/N: 10J00390000X0)**

8th & 9th generation Intel® Core™ i7/i5/i3 fanless system with one PCIe x4 expansion

**NISE 3900E2 System (P/N: 10J00390001X0)**

8th & 9th generation Intel® Core™ i7/i5/i3 fanless system with two PCIe x4 expansions

**NISE 3900P2 System (P/N: 10J00390002X0)**

8th & 9th generation Intel® Core™ i7/i5/i3 fanless system with two PCI expansions

**NISE 3900P2E System (P/N: 10J00390003X0)**

8th & 9th generation Intel® Core™ i7/i5/i3 fanless system with one PCI and one PCIe x4 expansion

**NISE 3900E-H310 System (P/N: 10J00390006X0)**

8th & 9th generation Intel® Core™ i7/i5/i3 fanless system with one PCIe x4 expansion

**NISE 3900R System (P/N: 10J00390004X0)**

8th & 9th generation Intel® Core™ i7/i5/i3 fanless system with two external 2.5" HDDs bracket to support RAID 0/1

**NISE 3900E/E2/P2/P2E/E-H310**

- **24V, 120W AC to DC power adapter w/o power cord (P/N: 7400120023X00)**

# CHAPTER 1: PRODUCT INTRODUCTION

## NISE 3900E Overview



Front View



Rear View

## Key Features

- Support 8th & 9th generation Intel® Core™ i7/i5/i3 LGA socket type embedded processor
- Intel® Q370 PCH
- Support 1 x 2.5" SATA HDD
- 1 x DVI-D, 1 x DP, and 1 x HDMI with independent display support
- Three Intel® GbE LAN ports; support WoL, teaming and PXE
- 1 x External M.2 socket and 1 x SIM card socket
- 6 x USB 3.0, 4 x USB 2.0, 2 x RS232/422/485 with auto flow control
- 1 x Internal mini-PCIe socket supports optional Wi-Fi/3.5G/4G LTE
- Support +9V to 30VDC input; ATX power mode
- One PCIe x4 expansion

## NISE 3900E Hardware Specifications

### CPU Support

- Support 8th & 9th generation Intel® Core™ i7/i5/i3 LGA socket type embedded processor
  - Intel® Core™ i7-9700TE, 8 Core, 1.8GHz, 12M Cache
  - Intel® Core™ i5-9500TE, 6 Core, 2.2GHz, 9M Cache
  - Intel® Core™ i3-9100TE, 4 Core, 2.2GHz, 6M Cache
  - Intel® Core™ i7-8700T, 6 Core, 2.4GHz, 12M Cache
  - Intel® Core™ i5-8500T, 6 Core, 2.1GHz, 9M Cache
  - Intel® Core™ i3-8100T, 4 Core, 3.1GHz, 6M Cache
- Turbo-boost disabled by default

### Main Memory

- 2 x DDR4 2400/2666 SO-DIMM sockets, support up to 32GB with un-buffered and non-ECC

### Display Option

- Three independent display
  - HDMI + DP + DVI-D
- Dual independent display
  - HDMI + DP
  - HDMI + DVI-D
  - DP + DVI-D

### Front I/O Interface Status LEDs

- 3 x LAN active LEDs
- 2 x GPO status/COM1/2 TX/RX LEDs
- 1 x HDD access LEDs
- 1 x Battery low
- 1 x M.2

### Front I/O Interface

- 1 x ATX power on/off switch
- 1 x DP
- 1 x Line-out and 1 x Mic-in
- 2 x Antenna holes
- 1 x External M.2 socket (M-key)
- 1 x SIM card holder
- 4 x USB 2.0 ports (500mA per each)

### Rear I/O Interface

- 2 x DB9 for COM1 & COM2
  - COM1: RS232/422/485 auto flow control
  - COM2: RS232/422/485 auto flow control
- 6 x USB 3.0 ports (900mA per each)
- 1 x DVI-D port
- 1 x HDMI port
- 2 x Intel® I210-IT GbE LAN ports; support WoL, teaming and PXE
- 1 x Intel® I219-LM GbE LAN port
- 1 x 3-pin remote power on/off switch
- +9V to 30V DC input

### Internal I/O

- COM3/COM4: internal box header, support RS232 only
- 8CH GPIO: internal pin header, supports 4 x GPO and 4 x GPI, TTL 5V level
- Onboard TPM2.0 (SLB9665) for data encryption purposes
- 1 x Internal M.2 (B-key), supports optional LTE

### Storage Device

- 1 x External M.2 socket (M-key SATA 3.0, PCIe x4)
- 1 x 2.5" HDD or SSD (SATA 3.0) drive bay



## Expansion Slot

- One PCIe x4 expansion slot
  - Add-on card length: 169mm max.
  - Power consumption: 10W/slot max.
- 1 x Internal mini-PCIe socket supports optional Wi-Fi/3.5G/4G LTE

## Power Requirements

- AT/ATX power mode (default: ATX power mode)
- Power input: +9 to +30V DC
- Power adapter: optional AC to DC power adapter (24V DC, 120W)

## Dimensions

- 215mm (W) x 272mm (D) x 94mm (H) without wall mount bracket (8.5" x 10.7" x 3.7")

## Construction

- Aluminum and metal chassis with fanless design

## Environment

- Operating temperature:
  - Ambient with air flow: -5°C to 55°C (According to IEC60068-2-1, IEC60068-2-2, IEC60068-2-14)
- Storage temperature: -20°C to 80°C
- Relative humidity: 10% to 95% (non-condensing)
- Shock protection:
  - HDD: 20G, half sine, 11ms, IEC60068-2-27
  - M.2: 50G, half sine, 11ms, IEC60068-2-27
- Vibration protection with HDD condition:
  - Random: 0.5Grms @ 5~500 Hz, IEC60068-2-64
  - Sinusoidal: 0.5Grms @ 5~500 Hz, IEC60068-2-6

- Vibration protection with SSD & M.2 condition:
  - Random: 2Grms @ 5~500 Hz, IEC60068-2-64
  - Sinusoidal: 2Grms @ 5~500 Hz, IEC60068-2-6

## Certifications

- CE approval- EN61000-6-2- EN61000-6-4
- FCC Class A

## OS Support List

- Windows 10 64-bit
- Linux Kernel 4.9

## Weight Information

- Gross weight: 6.54kg
- Net weight: 5kg

## NISE 3900E2/P2/P2E Overview



Front View



Rear View

## Key Features

- Support 8th & 9th generation Intel® Core™ i7/i5/i3 LGA socket type embedded processor
- Intel® Q370 PCH
- Support 1 x 2.5" SATA HDD
- 1 x DVI-D, 1 x DP, and 1 x HDMI with independent display support
- Three Intel® GbE LAN ports; support WoL, teaming and PXE
- 1 x External M.2 socket and 1 x SIM card socket
- 6 x USB 3.0, 4 x USB 2.0, 2 x RS232/422/485 with auto flow control
- 1 x Internal mini-PCIe socket supports optional Wi-Fi/3.5G/4G LTE
- Support +9V to 30VDC input; ATX power mode
- 2 x PCI or PCIe x4 expansions

## NISE 3900E2/P2/P2E Hardware Specifications

### CPU Support

- Support 8th & 9th generation Intel® Core™ i7/i5/i3 LGA socket type embedded processor
  - Intel® Core™ i7-9700TE, 8 Core, 1.8GHz, 12M Cache
  - Intel® Core™ i5-9500TE, 6 Core, 2.2GHz, 9M Cache
  - Intel® Core™ i3-9100TE, 4 Core, 2.2GHz, 6M Cache
  - Intel® Core™ i7-8700T, 6 Core, 2.4GHz, 12M Cache
  - Intel® Core™ i5-8500T, 6 Core, 2.1GHz, 9M Cache
  - Intel® Core™ i3-8100T, 4 Core, 3.1GHz, 6M Cache
- Turbo-boost disabled by default

### Main Memory

- 2 x DDR4 2400/2666 SO-DIMM sockets, support up to 32GB with un-buffered and non-ECC

### Display Option

- Three independent display
  - HDMI + DP + DVI-D
- Dual independent display
  - HDMI + DP
  - HDMI + DVI-D
  - DP + DVI-D

### Front I/O Interface Status LEDs

- 3 x LAN active LEDs
- 2 x GPO status/COM1/2 TX/RX LEDs
- 1 x HDD access LEDs
- 1 x Battery low
- 1 x M.2

### Front I/O Interface

- 1 x ATX power on/off switch
- 1 x DP
- 1 x Line-out and 1 x Mic-in
- 2 x Antenna holes
- 1 x External M.2 socket (M-key)
- 1 x SIM card holder
- 4 x USB 2.0 ports (500mA per each)

### Rear I/O Interface

- 2 x DB9 for COM1 & COM2
  - COM1: RS232/422/485 auto flow control
  - COM2: RS232/422/485 auto flow control
- 6 x USB 3.0 ports (900mA per each)
- 1 x DVI-D port
- 1 x HDMI port
- 2 x Intel® I210-IT GbE LAN ports; support WoL, teaming and PXE
- 1 x Intel® I219-LM GbE LAN port
- 1 x 3-pin remote power on/off switch
- +9V to 30V DC input

### Internal I/O

- COM3/COM4: internal box header, support RS232 only
- 8CH GPIO: internal pin header, support 4 x GPO and 4 x GPI, TTL 5V level
- Onboard TPM2.0 (SLB9665) for data encryption purposes
- 1 x Internal M.2 (B-key), supports optional LTE

### Storage Device

- 1 x External M.2 socket (M-key SATA 3.0, PCIe x4)
- 1 x 2.5" HDD or SSD (SATA 3.0) drive bay

## Expansion Slot

- NISE 3900E2: two PCIe x4 expansion slots
  - Add-on card length: one 169mm max, and one 240mm max.
  - Power consumption: 10W/slot max
- NISE 3900P2: two PCI expansion slots
  - Add-on card length: one 169mm max, and one 240mm max.
  - Power consumption: 10W/slot max
- NISE 3900P2E: one PCIe x4 and one PCI expansion slot
  - Add-on card length: one 169mm max for PCIe x4, and one 240mm max for PCI
  - Power consumption: 10W/slot max
- 1 x Internal mini-PCIe socket supports optional Wi-Fi/3.5G/4G LTE

## Power Requirements

- AT/ATX power mode (default: ATX power mode)
- Power input: +9 to +30V DC
- Power adapter: optional AC to DC power adapter (24V DC, 120W)

## Dimensions

- 215mm (W) x 272mm (D) x 94mm (H) without wall mount bracket (8.5" x 10.7" x 4.5")

## Construction

- Aluminum and metal chassis with fanless design

## Environment

- Operating temperature:  
Ambient with air flow: -5°C to 55°C  
(According to IEC60068-2-1, IEC60068-2-2, IEC60068-2-14)

- Storage temperature: -20°C to 80°C
- Relative humidity: 10% to 95% (non-condensing)
- Shock protection:
  - HDD: 20G, half sine, 11ms, IEC60068-2-27
  - M.2: 50G, half sine, 11ms, IEC60068-2-27
- Vibration protection with HDD condition:
  - Random: 0.5Grms @ 5~500 Hz, IEC60068-2-64
  - Sinusoidal: 0.5Grms @ 5~500 Hz, IEC60068-2-6
- Vibration protection with SSD & M.2 condition:
  - Random: 2Grms @ 5~500 Hz, IEC60068-2-64
  - Sinusoidal: 2Grms @ 5~500 Hz, IEC60068-2-6

## Certifications

- CE approval- EN61000-6-2- EN61000-6-4
- FCC Class A

## OS Support List

- Windows 10 64-bit
- Linux Kernel 4.9

## Weight Information

- Gross weight: 6.84kg
- Net weight: 5.3kg

## NISE 3900E-H310 Overview



Front View



Rear View

## Key Features

- Support 8th & 9th generation Intel® Core™ i7/i5/i3 LGA socket type embedded processor
- Intel® H310 PCH
- Support 1 x 2.5" SATA HDD
- 1 x DVI-D and 1 x HDMI with independent display support
- Two Intel® GbE LAN ports
- 1 x External M.2 socket and 1 x SIM card socket
- 4 x USB 3.0, 2 x USB 2.0, 2 x RS232/422/485 with auto flow control
- 2 x Internal mini-PCIe sockets support optional Wi-Fi/3.5G/4G LTE
- Support +9V to 30VDC input; ATX power mode
- One PCIe x4 expansion

## NISE 3900E-H310 Hardware Specifications

### CPU Support

- Support 8th & 9th generation Intel® Core™ i7/i5/i3 LGA socket type embedded processor
  - Intel® Core™ i7-9700TE, 8 Core, 1.8GHz, 12M Cache
  - Intel® Core™ i5-9500TE, 6 Core, 2.2GHz, 9M Cache
  - Intel® Core™ i3-9100TE, 4 Core, 2.2GHz, 6M Cache
  - Intel® Core™ i7-8700T, 6 Core, 2.4GHz, 12M Cache
  - Intel® Core™ i5-8500T, 6 Core, 2.1GHz, 9M Cache
  - Intel® Core™ i3-8100T, 4 Core, 3.1GHz, 6M Cache
- Turbo-boost disabled by default

### Main Memory

- 2 x DDR4 2400/2666 SO-DIMM sockets, support up to 32GB with un-buffered and non-ECC

### Display Option

- Two independent display
  - HDMI + DVI-D

### Front I/O Interface Status LEDs

- 3 x LAN active LEDs
- 2 x GPO status/COM1/2 TX/RX LEDs
- 1 x HDD access LEDs
- 1 x Battery low
- 1 x M.2

### Front I/O Interface

- 1 x ATX power on/off switch
- 1 x Line-out and 1 x Mic-in
- 2 x Antenna holes

- 1 x External M.2 socket (M-key)
- 1 x SIM card holder
- 2 x USB 2.0 ports (500mA per each)

### Rear I/O Interface

- 2 x DB9 for COM1 & COM2
  - COM1: RS232/422/485 auto flow control
  - COM2: RS232/422/485 auto flow control
- 4 x USB 3.1 ports (900mA per each)
- 1 x DVI-D port
- 1 x HDMI port
- 2 x Intel® I210AT GbE LAN ports; support WoL, teaming and PXE
- 1 x 3-pin remote power on/off switch
- +9V to 30V DC input

### Internal I/O

- COM3/COM4: internal box header, support RS232 only
- 8CH GPIO: internal pin header, support 4 x GPO and 4 x GPI, TTL 5V level
- Onboard TPM2.0 (SLB9665) for data encryption purposes
- 1 x Internal M.2 (B-key), supports optional LTE

### Storage Device

- 1 x Internal M.2 socket (M-key SATA 3.0)
- 1 x 2.5" HDD or SSD (SATA 3.0) drive bay

### Expansion Slot

- One PCIe x4 expansion slot
  - Add-on card length: 169mm max.
  - Power consumption: 10W/slot max.
- 1 x Internal mini-PCIe socket support optional Wi-Fi/3.5G/4G LTE

## Power Requirements

- AT/ATX power mode (default: ATX power mode)
- Power input: +9 to +30V DC
- Power adapter: optional AC to DC power adapter (24V DC, 120W)

## Dimensions

- 215mm (W) x 272mm (D) x 94mm (H) without wall mount bracket (8.5" x 10.7" x 3.7")

## Construction

- Aluminum and metal chassis with fanless design

## Environment

- Operating temperature:  
Ambient with air flow: -5°C to 55°C  
(According to IEC60068-2-1, IEC60068-2-2, IEC60068-2-14)
- Storage temperature: -20°C to 80°C
- Relative humidity: 10% to 95% (non-condensing)
- Shock protection:
  - HDD: 20G, half sine, 11ms, IEC60068-2-27
  - M.2: 50G, half sine, 11ms, IEC60068-2-27
- Vibration protection with HDD condition:
  - Random: 0.5Grms @ 5~500 Hz, IEC60068-2-64
  - Sinusoidal: 0.5Grms @ 5~500 Hz, IEC60068-2-6
- Vibration protection with SSD & M.2 condition:
  - Random: 2Grms @ 5~500 Hz, IEC60068-2-64
  - Sinusoidal: 2Grms @ 5~500 Hz, IEC60068-2-6

## Certifications

- CE approval- EN61000-6-2- EN61000-6-4
- FCC Class A

## OS Support List

- Windows 10 64-bit
- Linux Kernel 4.9

## Weight Information

- Gross weight: 6.54kg
- Net weight: 5kg

## NISE 3900R Overview



Front View



Rear View

## Key Features

- Support 8th & 9th generation Intel® Core™ i7/i5/i3 LGA socket type embedded processor
- Intel® Q370 PCH
- Support 1 x 2.5" SATA HDD
- 1 x DVI-D, 1 x DP, and 1 x HDMI with independent display support
- Three Intel® GbE LAN ports; support WoL, teaming and PXE
- 1 x External M.2 socket and 1 x SIM card socket
- 6 x USB 3.0, 4 x USB 2.0, 2 x RS232/422/485 with auto flow control
- 1 x Internal mini-PCIe socket supports optional Wi-Fi/3.5G/4G LTE
- Support +9V to 30VDC input; ATX power mode



## NISE 3900R Hardware Specifications

### CPU Support

- Support 8th & 9th generation Intel® Core™ i7/i5/i3 LGA socket type embedded processor
  - Intel® Core™ i7-9700TE, 8 Core, 1.8GHz, 12M Cache
  - Intel® Core™ i5-9500TE, 6 Core, 2.2GHz, 9M Cache
  - Intel® Core™ i3-9100TE, 4 Core, 2.2GHz, 6M Cache
  - Intel® Core™ i7-8700T, 6 Core, 2.4GHz, 12M Cache
  - Intel® Core™ i5-8500T, 6 Core, 2.1GHz, 9M Cache
  - Intel® Core™ i3-8100T, 4 Core, 3.1GHz, 6M Cache
- Turbo-boost disabled by default

### Main Memory

- 2 x DDR4 2400/2666 SO-DIMM sockets, support up to 32GB with un-buffered and non-ECC

### Display Option

- Three independent display
  - HDMI + DP+ DVI-D
- Dual independent display
  - HDMI + DP
  - HDMI + DVI-D
  - DP + DVI-D

### Front I/O Interface Status LEDs

- 3 x LAN active LEDs
- 2 x GPO status/COM1/2 TX/RX LEDs
- 1 x HDD access LEDs
- 1 x Battery low
- 1 x M.2

### Front I/O Interface

- 1 x ATX power on/off switch
- 1 x DP
- 1 x Line-out and 1 x Mic-in
- 2 x Antenna holes
- 1 x External M.2 socket (M-key)
- 1 x SIM card holder
- 4 x USB 2.0 ports (500mA per each)

### Rear I/O Interface

- 2 x DB9 for COM1 & COM2
  - COM1: RS232/422/485 auto flow control
  - COM2: RS232/422/485 auto flow control
- 6 x USB 3.0 ports (900mA per each)
- 1 x DVI-D port
- 1 x HDMI port
- 2 x Intel® I210-IT GbE LAN ports; support WoL, teaming and PXE
- 1 x Intel® I219-LM GbE LAN port
- 1 x 3-pin remote power on/off switch
- +9V to 30V DC input

### Internal I/O

- COM3/COM4: internal box header, support RS232 only
- 8CH GPIO: internal pin header, support 4 x GPO and 4 x GPI, TTL 5V level
- Onboard TPM2.0 (SLB9665) for data encryption purposes
- 1 x Internal M.2 (B-key), supports optional LTE

### Storage Device

- 1 x Internal M.2 socket (M-key SATA 3.0, PCIe x4)
- 2 x 2.5" HDD bracket trays

## Expansion Slot

- 1 x Internal mini-PCIe socket supports optional Wi-Fi/3.5G/4G LTE

## Power Requirements

- AT/ATX power mode (default: ATX power mode)
- Power input: +9 to +30V DC
- Power adapter: optional AC to DC power adapter (24V DC, 120W)

## Dimensions

- 215mm (W) x 272mm (D) x 94mm (H) without wall mount bracket (8.5" x 10.7" x 3.7")

## Construction

- Aluminum and metal chassis with fanless design

## Environment

- Operating temperature:  
Ambient with air flow: -5°C to 55°C  
(According to IEC60068-2-1, IEC60068-2-2, IEC60068-2-14)
- Storage temperature: -20°C to 80°C
- Relative humidity: 10% to 95% (non-condensing)
- Shock protection:
  - HDD: 20G, half sine, 11ms, IEC60068-2-27
  - M.2: 50G, half sine, 11ms, IEC60068-2-27
- Vibration protection with HDD condition:
  - Random: 0.5Grms @ 5~500 Hz, IEC60068-2-64
  - Sinusoidal: 0.5Grms @ 5~500 Hz, IEC60068-2-6
- Vibration protection with SSD & M.2 condition:
  - Random: 2Grms @ 5~500 Hz, IEC60068-2-64
  - Sinusoidal: 2Grms @ 5~500 Hz, IEC60068-2-6

## Certifications

- CE approval- EN61000-6-2- EN61000-6-4
- FCC Class A

## OS Support List

- Windows 10 64-bit
- Linux Kernel 4.9

## Weight Information

- Gross weight: 6.64kg
- Net weight: 5.1kg

## Knowing Your NISE 3900 Series

### NISE 3900E & NISE 3900R Front Panel

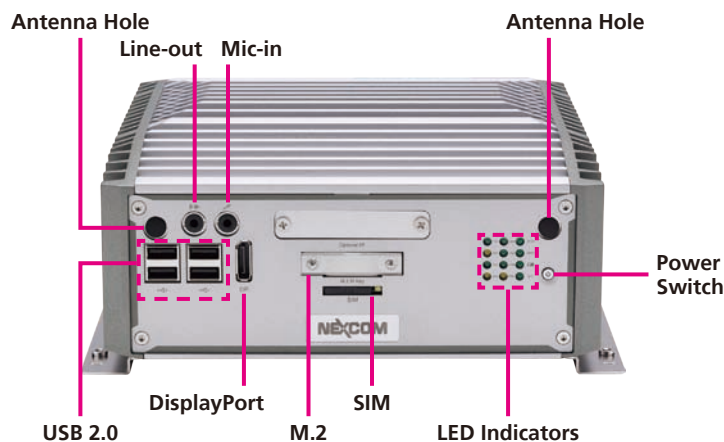

#### Antenna Hole

The external antenna mounting holes are used to mount and connect optional external antennas.

#### Line-out

Used to connect a headphone or a speaker.

#### Mic-in

Used to connect an external microphone.

#### USB 2.0

Used to connect USB 2.0/1.1 devices.

#### DisplayPort

Used to connect a DisplayPort interface monitor.

#### M.2 and SIM Card Slot

Used to install an M.2 and a SIM card.

#### LED Indicators

Indicates the COM port, LAN, GPO, storage and M.2 activity as well as the low battery status of the system.

#### Power Switch

Press to power-on or power-off the system.

## NISE 3900E Rear Panel

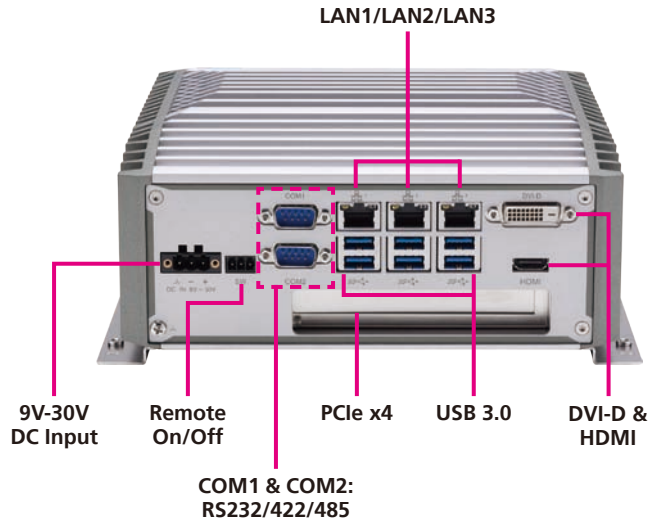

### 9V-30V DC Input

Used to plug a DC power cord.

### Remote On/Off Switch

Used to connect a remote to power on/off the system.

### COM1 & COM2

Two DB9 ports used to connect RS232/422/485 compatible devices.

### LAN1/LAN2/LAN3

Used to connect the system to a local area network.

### USB 3.0

Used to connect USB 3.0/2.0 devices.

### DVI-D

Used to connect a DVI-D interface monitor.

### HDMI

Used to connect a HDMI interface monitor.

## NISE 3900R Rear Panel



### PCIe x4 (Expansion Slot)

NISE 3900E: One PCIe x4 expansion slot used to install add-on cards.

### Bracket Tray (NISE 3900R)

Removable bracket tray used to install two 2.5" storage drives.

## NISE 3900E-H310 Front Panel

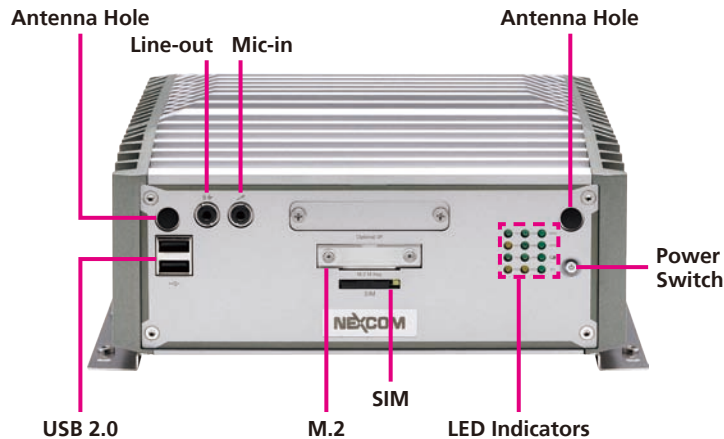

### Antenna Hole

The external antenna mounting holes are used to mount and connect optional external antennas.

### Line-out

Used to connect a headphone or a speaker.

### Mic-in

Used to connect an external microphone.

### USB 2.0

Used to connect USB 2.0/1.1 devices.

### M.2 and SIM Card Slot

Used to install an M.2 and a SIM card.

### LED Indicators

Indicates the COM port, LAN, GPO, storage and M.2 activity as well as the low battery status of the system.

### Power Switch

Press to power-on or power-off the system.

## NISE 3900E-H310 Rear Panel

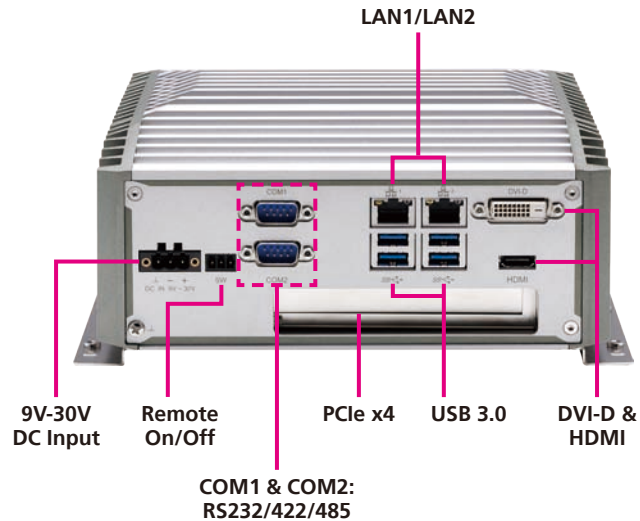

### 9V-30V DC Input

Used to plug a DC power cord.

### Remote On/Off Switch

Used to connect a remote to power on/off the system.

### COM1 & COM2

Two DB9 ports used to connect RS232/422/485 compatible devices.

### LAN1/LAN2

Used to connect the system to a local area network.

### USB 3.0

Used to connect USB 3.0/2.0 devices.

### DVI-D

Used to connect a DVI-D interface monitor.

### HDMI

Used to connect a HDMI interface monitor.

### PCIe x4 (Expansion Slot)

NISE 3900E-H310: One PCIe x4 expansion slot used to install add-on cards.

## NISE 3900E2/P2/P2E Front Panel

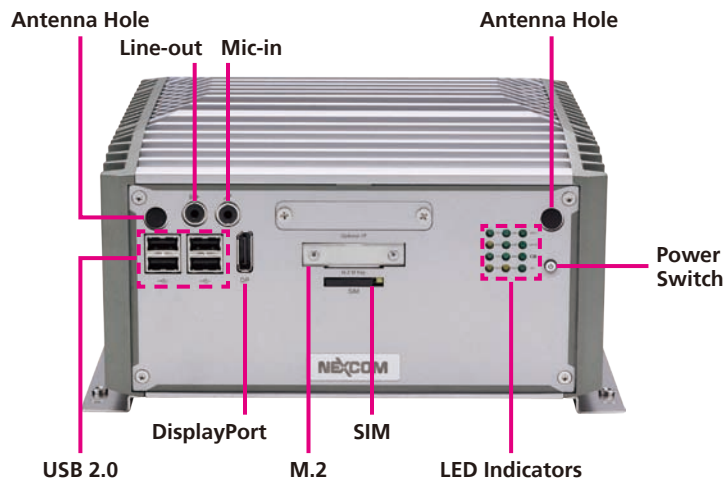

### Antenna Hole

The external antenna mounting holes are used to mount and connect optional external antennas.

### Line-out

Used to connect a headphone or a speaker.

### Mic-in

Used to connect an external microphone.

### USB 2.0

Used to connect USB 2.0/1.1 devices.

### DisplayPort

Used to connect a DisplayPort interface monitor.

### M.2 and SIM Card Slot

Used to install an M.2 and a SIM card.

### LED Indicators

Indicates the COM port, LAN, GPO, storage and M.2 activity as well as the battery status of the system.

### Power Switch

Press to power-on or power-off the system.

## NISE 3900E2/P2/P2E Rear Panel

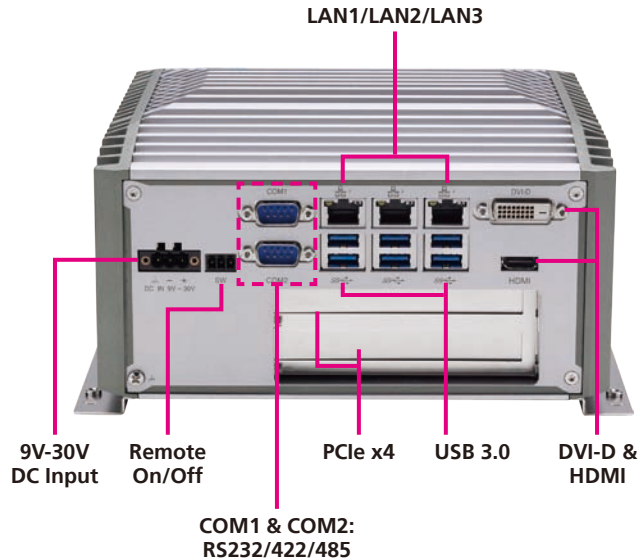

### 9V-30V DC Input

Used to plug a DC power cord.

### Remote On/Off Switch

Used to connect a remote to power on/off the system.

### COM1 & COM2

Two DB9 ports used to connect RS232/422/485 compatible devices.

### LAN1/LAN2/LAN3

Used to connect the system to a local area network.

### USB 3.0

Used to connect USB 3.0/2.0 devices.

### DVI-D

Used to connect a DVI-D interface monitor.

### HDMI

Used to connect a HDMI interface monitor.

### PCIe x4 (Expansion Slots)

NISE 3900E2/P2/P2E: Two PCIe x4 expansion slots used to install add-on cards.



# Mechanical Dimensions

## NISE 3900E

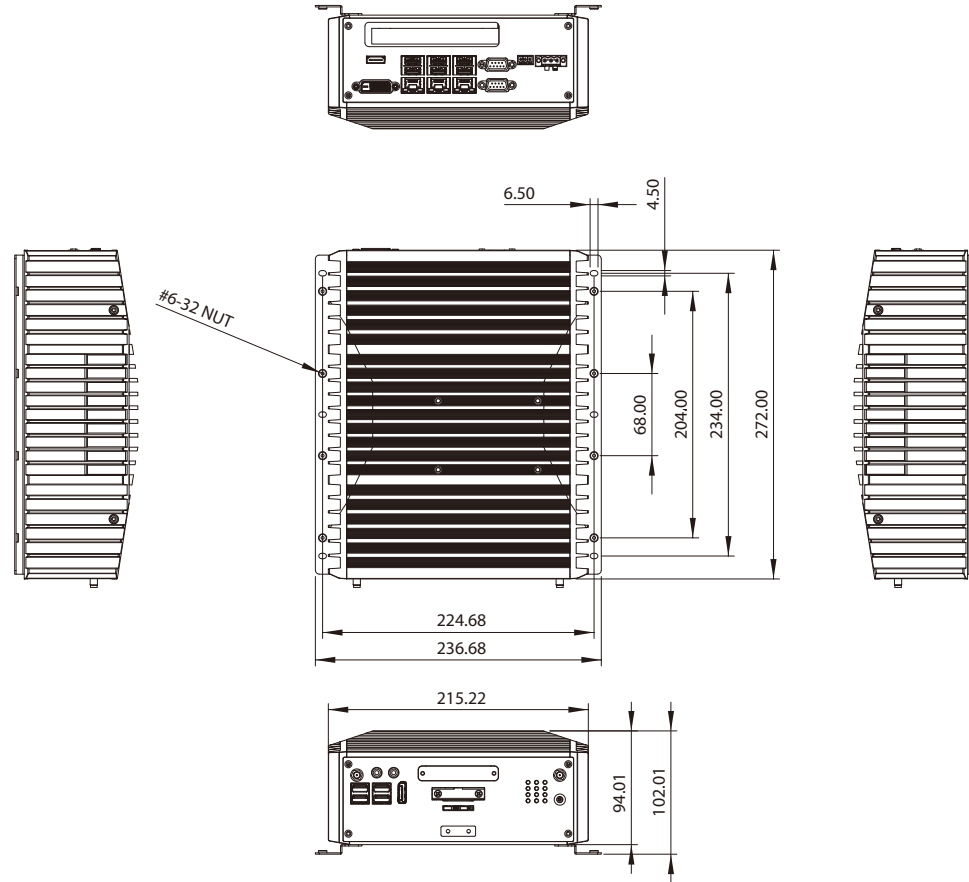

## NISE 3900E2/NISE 3900P2/NISE 3900P2E

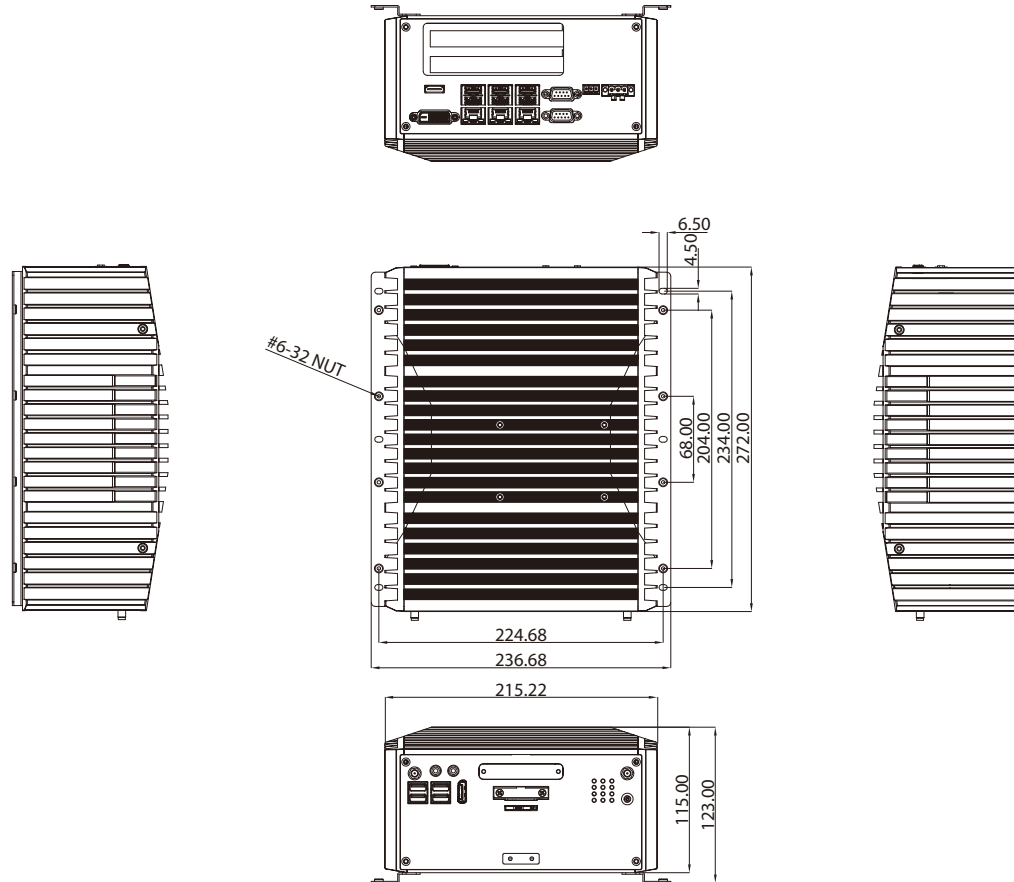

## NISE 3900E-H310

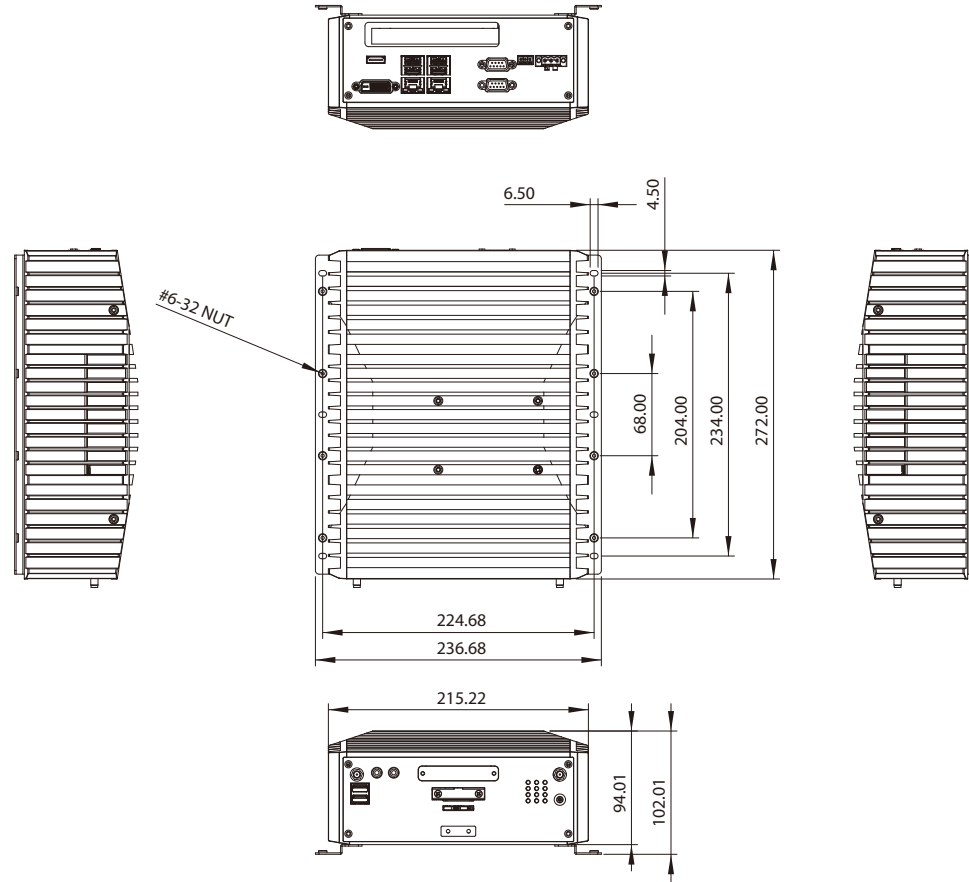

# NISE 3900R

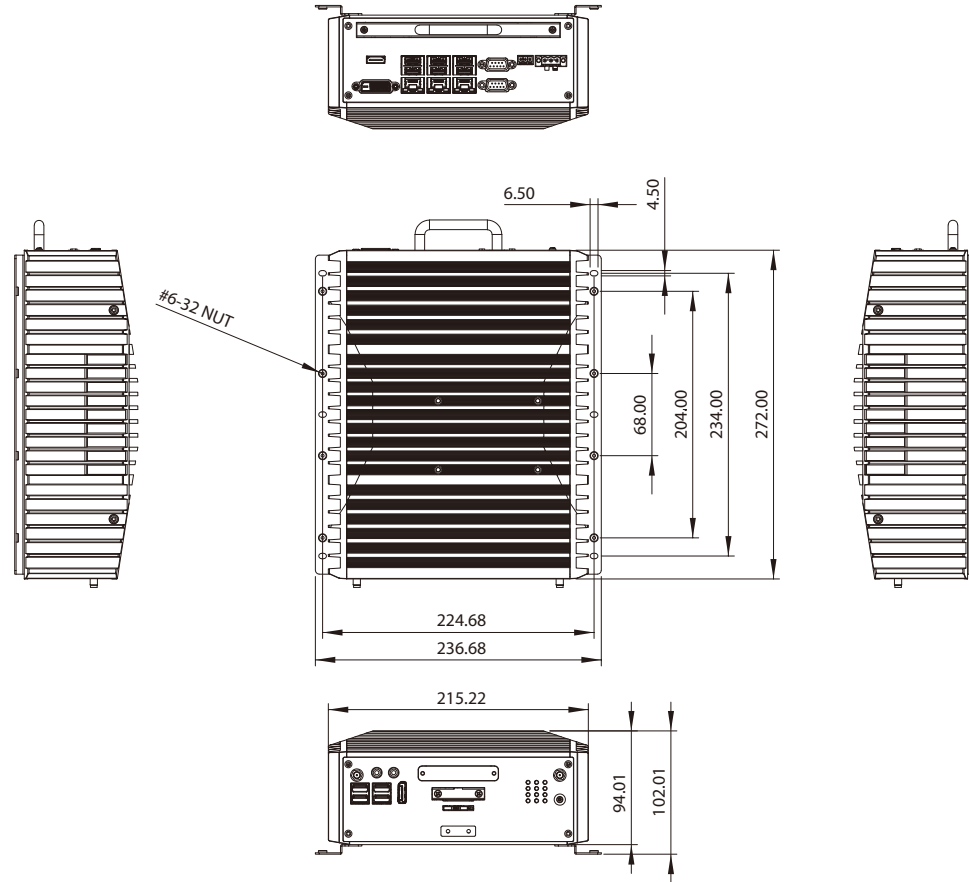

## CHAPTER 2: JUMPERS AND CONNECTORS

This chapter describes how to set the jumpers and connectors on the NISE 3900 series motherboard.

### Before You Begin

- Ensure you have a stable, clean working environment. Dust and dirt can get into components and cause a malfunction. Use containers to keep small components separated.
- Adequate lighting and proper tools can prevent you from accidentally damaging the internal components. Most of the procedures that follow require only a few simple tools, including the following:
  - A Philips screwdriver
  - A flat-tipped screwdriver
  - A set of jewelers screwdrivers
  - A grounding strap
  - An anti-static pad
- Using your fingers can disconnect most of the connections. It is recommended that you do not use needle-nosed pliers to disconnect connections as these can damage the soft metal or plastic parts of the connectors.
- Before working on internal components, make sure that the power is off. Ground yourself before touching any internal components, by touching a metal object. Static electricity can damage many of the electronic components. Humid environments tend to have less static electricity than

dry environments. A grounding strap is warranted whenever danger of static electricity exists.

### Precautions

Computer components and electronic circuit boards can be damaged by discharges of static electricity. Working on computers that are still connected to a power supply can be extremely dangerous.

Follow the guidelines below to avoid damage to your computer or yourself:

- Always disconnect the unit from the power outlet whenever you are working inside the case.
- If possible, wear a grounded wrist strap when you are working inside the computer case. Alternatively, discharge any static electricity by touching the bare metal chassis of the unit case, or the bare metal body of any other grounded appliance.
- Hold electronic circuit boards by the edges only. Do not touch the components on the board unless it is necessary to do so. Don't flex or stress the circuit board.
- Leave all components inside the static-proof packaging that they shipped with until they are ready for installation.
- Use correct screws and do not over tighten screws.

## Jumper Settings

A jumper is the simplest kind of electric switch. It consists of two metal pins and a cap. When setting the jumpers, ensure that the jumper caps are placed on the correct pins. When the jumper cap is placed on both pins, the jumper is short. If you remove the jumper cap, or place the jumper cap on just one pin, the jumper is open.

Refer to the illustrations below for examples of what the 2-pin and 3-pin jumpers look like when they are short (on) and open (off).

Two-Pin Jumpers: Open (Left) and Short (Right)

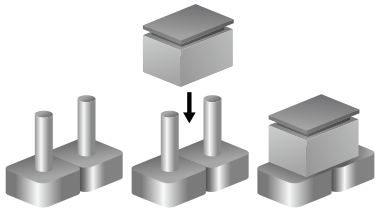

Three-Pin Jumpers: Pins 1 and 2 are Short

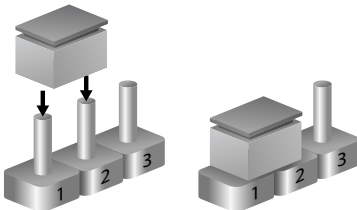

# Locations of the Jumpers and Connectors for the NISE 3900 Series

The figure below is the top view of the main board used in the NISE 3900 series. It shows the locations of the jumpers and connectors.

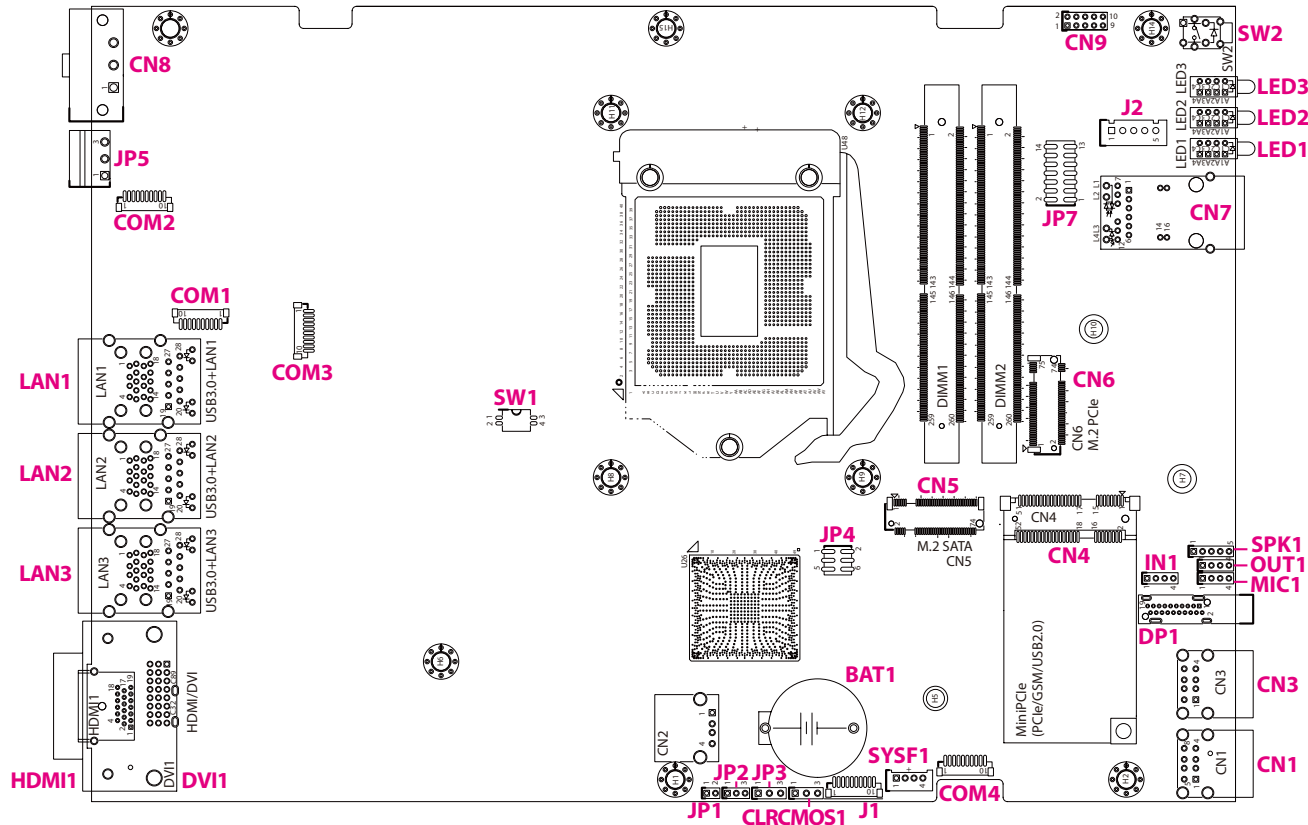

The figure below is the bottom view of the main board.

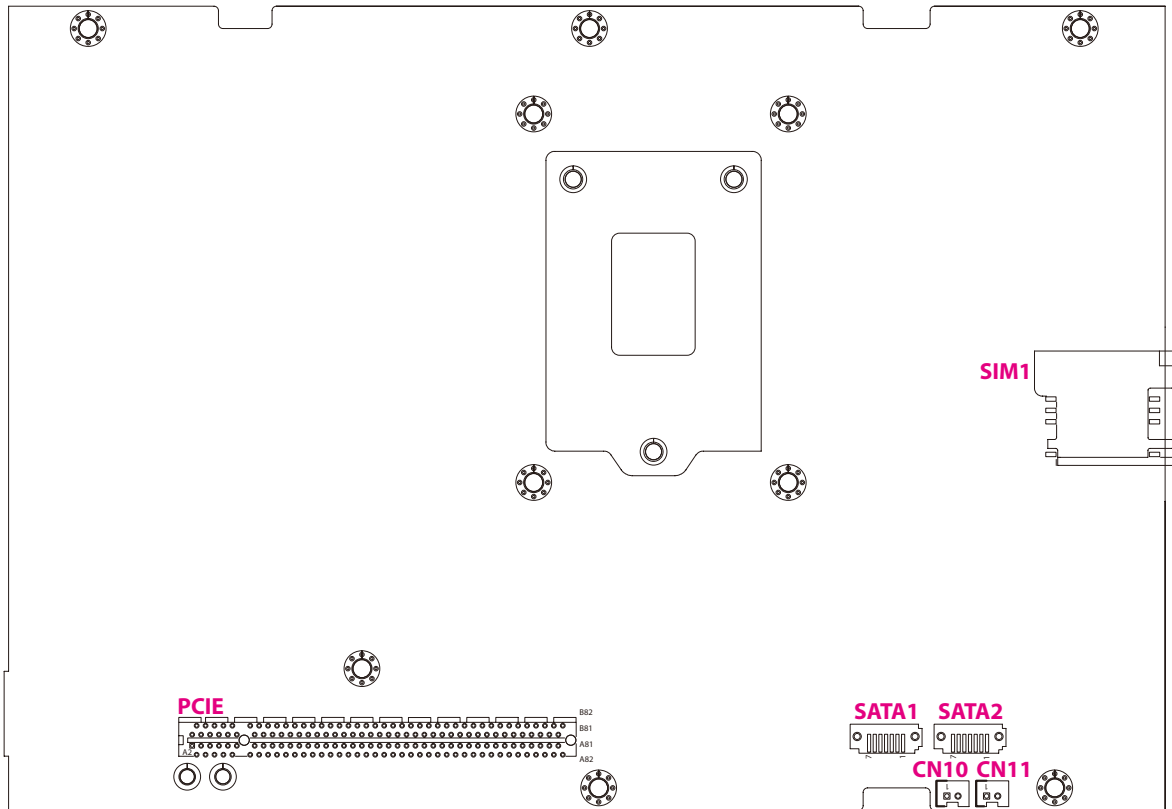



## Jumpers and DIP Switch Settings

### AT/ATX Power Select

Connector type: 1x3 3-pin header, 2.54mm pitch

Connector location: JP3



Pin	Settings
1-2 On	AT Mode
2-3 On	ATX Mode (Default)

Pin	Settings
1	AT_PWRBT#
2	S_PWRBTN#
3	PBT_SW

### Clear CMOS

Connector type: 1x3 3-pin header, 2.54mm pitch

Connector location: CLRCMOS1



Pin	Settings
1-2 On	Normal (Default)
2-3 On	Clear CMOS

Pin	Settings
1	NC
2	S_RTCRST#
3	GND

## CPU CFG Strap Pin

Connector type: 2-pin On/Off DIP switch

Connector location: SW1

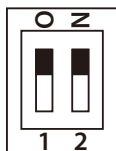

Pin 1	Pin 2	Setting
ON	ON	1 x8, 2 x4 PCI Express*
ON	OFF	Reserved
OFF	ON	2 x8 PCI Express*
OFF	OFF	1 x16 PCI Express* (Default)

Pin	Definition
1	GND
2	GND
3	CFG_5
4	CFG_6

## Connector Pin Definitions

### External I/O Interfaces - Front Panel

#### Power Button

Connector location: SW2



Pin	Definition	Pin	Definition
1	GND	2	PBT_PU
3	PBT_PU	4	GND
A1	PWRLED_N	C1	N19915412
MH1	GND	MH2	GND

#### LED Indicators

Connector location: LED1, LED2 and LED3

##### LED1



TX1



RX1



TX2



RX2

##### LED2



LAN1



LAN2



LAN3



HDD

##### LED3



GPO1



GPO2



BAT



M.2

	Pin	Definition	Pin	Definition
LED1	A1	VCC3	C1	COM2_RXLEDN
	A2	VCC3	C2	COM2_TXLEDN
	A3	VCC3	C3	COM1_RXLEDN
	A4	VCC3	C4	COM1_TXLEDN
LED2	A1	VCC3	C1	I_SATALEDN
	A2	VCC3	C2	LAN3LEDACTN
	A3	VCC3	C3	LAN2LEDACTN
	A4	VCC3	C4	LAN1LEDACTN
LED3	A1	VCC3	C1	SATA_M2LEDL
	A2	VCC3	C2	BAT_LOWL
	A3	VCC3	C3	SIO_GP80
	A4	VCC3	C4	SIO_GP81

## DisplayPort

Connector type: DisplayPort

Connector location: DP1

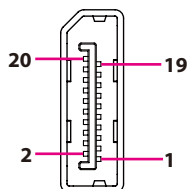

Pin	Definition	Pin	Definition
1	LANE0_P	2	GND
3	LANE0_N	4	LANE1_P
5	GND	6	LANE1_N
7	LANE2_P	8	GND
9	LANE2_N	10	LANE3_P
11	GND	12	LANE3_N
13	CONFIG1	14	CONFIG2
15	AUX_P	16	GND
17	AUX_N	18	DPHPD
19	GND	20	3V3DPPWR

## SIM Card Socket

Connector location: SIM1

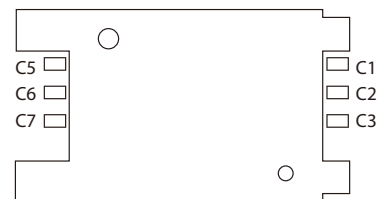

Pin	Definition	Pin	Definition
C1	UIM_PWR	C2	UIM_RESET
C3	UIM_CLK	C5	GND
C6	UIM_VPP	C7	UIM_DATA
MH1	GND	MH2	GND

## USB 2.0 Ports (N/A on NISE 3900E-H310)

Connector type: Dual USB 2.0 port

Connector location: CN3

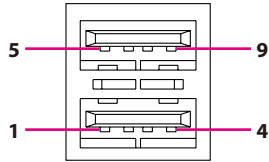

Pin	Definition	Pin	Definition
1	5V_USB4	2	USB2N_12
3	USB2P_12	4	GND
5	5V_USB4	6	USB2N_13
7	USB2P_13	8	GND
MH1	GND_CHASSIS	MH2	GND_CHASSIS
MH3	GND_CHASSIS	MH4	GND_CHASSIS

## USB 2.0 Ports

Connector type: Dual USB 2.0 port

Connector location: CN1

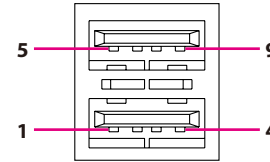

Pin	Definition	Pin	Definition
1	5VUSB2	2	USB2N_9
3	USB2P_9	4	GND
5	5VUSB2	6	USB2N_5
7	USB2P_5	8	GND
MH1	GND_CHASSIS	MH2	GND_CHASSIS
MH3	GND_CHASSIS	MH4	GND_CHASSIS

## External I/O Interfaces - Rear Panel

### 9V - 30V DC Power Input

Connector type: Phoenix Contact 1x3 3-pin terminal block

Connector location: CN8

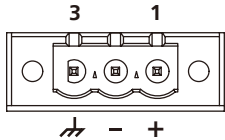

Pin	Definition
1	VIN_1
2	VIN_VSS
3	VINPIN3

### Remote Power On/Off & S3 Connector

Connector type: 3-pin switch

Connector location: JP5



Pin	Definition
1	PWRBTN#_J
2	GND
3	L_SLPS3N

## LAN1 and USB 3.1 Ports (Not available on NISE 3900E-H310)

Connector type: RJ45 port with LEDs

Dual USB 3.1 port

Connector location: LAN1A (USB) and LAN1B (LAN)

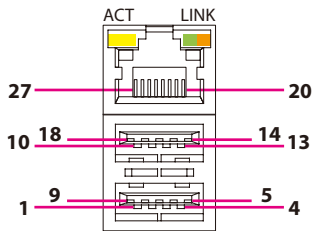

Act	Status
Flashing Yellow	Data activity
Off	No activity

Link	Status
Steady Green	1G network link
Steady Orange	100Mbps network link
Off	No link

Pin	Definition	Pin	Definition
1	5VUSB1	2	USB2N_10
3	USB2P_10	4	GND
5	S_USB31_RXN5	6	S_USB31_RXP5
7	GND	8	USB31_TXN5
9	USB31_TXP5	10	5VUSB1
11	USB2N_11	12	USB2P_11
13	GND	14	S_USB31_RXN6
15	S_USB31_RXP6	16	GND

Pin	Definition	Pin	Definition
17	USB31_TXN6	18	USB31_TXP6
19	LAN3TCT	20	MDI_PLUS0
21	MDI_MINUS0	22	MDI_PLUS1
23	MDI_MINUS1	24	MDI_PLUS2
25	MDI_MINUS2	26	MDI_PLUS3
27	MDI_MINUS3	28	GND
29	LAN1_ACTPW	30	LAN1LEDACTN
31	LAN1LED100#	32	LAN1LINK

## LAN2 and USB 3.1 Ports

Connector type: RJ45 port with LEDs

Dual USB 3.1 port

Connector location: LAN2A (USB) and LAN2B (LAN)

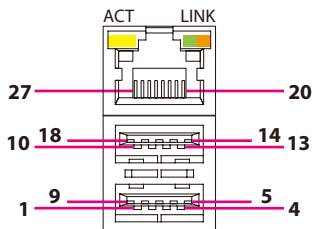

Act	Status
Flashing Yellow	Data activity
Off	No activity

Link	Status
Steady Green	1G network link
Steady Orange	100Mbps network link
Off	No link

Pin	Definition	Pin	Definition
1	5VUSB3	2	USB2N_1
3	USB2P_1	4	GND
5	S_USB31_RXN1	6	S_USB31_RXP1
7	GND	8	USB31_TXN1
9	USB31_TXP1	10	5VUSB3
11	USB2N_7	12	USB2P_7
13	GND	14	S_USB31_RXN2
15	S_USB31_RXP2	16	GND

Pin	Definition	Pin	Definition
17	USB31_TXN2	18	USB31_TXP2
19	LAN2TCT	20	LAN2MDI0P
21	LAN2MDI0N	22	LAN2MDI1P
23	LAN2MDI1N	24	LAN2MDI2P
25	LAN2MDI2N	26	LAN2MDI3P
27	LAN2MDI3N	28	GND
29	LAN2ACTCON	30	LAN2LEDACTN
31	LAN2100CON	32	LAN2LINK1GN



## LAN3 and USB 3.1 Ports

Connector type: RJ45 port with LEDs

Dual USB 3.1 port

Connector location: LAN3A (USB) and LAN3B (LAN)

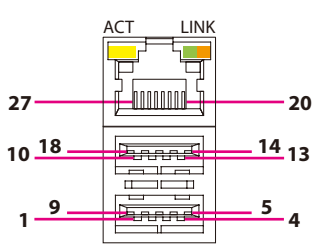

Act	Status
Flashing Yellow	Data activity
Off	No activity

Link	Status
Steady Green	1G network link
Steady Orange	100Mbps network link
Off	No link

Pin	Definition	Pin	Definition
1	5VUSB3	2	USB2N_1
3	USB2P_1	4	GND
5	S_USB31_RXN1	6	S_USB31_RXP1
7	GND	8	USB31_TXN1
9	USB31_TXP1	10	5VUSB3
11	USB2N_7	12	USB2P_7
13	GND	14	S_USB31_RXN2
15	S_USB31_RXP2	16	GND

Pin	Definition	Pin	Definition
17	USB31_TXN2	18	USB31_TXP2
19	LAN2TCT	20	LAN2MDI0P
21	LAN2MDI0N	22	LAN2MDI1P
23	LAN2MDI1N	24	LAN2MDI2P
25	LAN2MDI2N	26	LAN2MDI3P
27	LAN2MDI3N	28	GND
29	LAN2ACTCON	30	LAN2LEDACTN
31	LAN2100CON	32	LAN2LINK1GN

## DVI-D Connector

Connector type: 24-pin D-Sub, 2.0mm-M-180 (DVI)

Connector location: DVI1

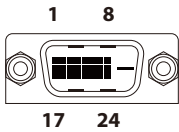

Pin	Definition	Pin	Definition
1	DVI_D2_N	2	DVI_D2_P
3	GND	4	NC
5	NC	6	DVI_DDC_SCL
7	DVI_DDC_SDA	8	NC
9	DVI_D1_N	10	DVI_D1_P
11	GND	12	NC
13	NC	14	5VDVIPWR
15	GND	16	DVI_HPD
17	DVI_D0_N	18	DVI_D0_P
19	GND	20	NC
21	NC	22	GND
23	DVI_CK_P	24	DVI_CK_N

## HDMI

Connector type: HDMI port

Connector location: HDMI1

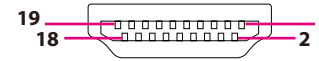

Pin	Definition	Pin	Definition
1	HDMI_D2_P	2	GND
3	HDMI_D2_N	4	HDMI_D1_P
5	GND	6	HDMI_D1_N
7	HDMI_D0_P	8	GND
9	HDMI_D0_N	10	HDMI_CK_P
11	GND	12	HDMI_CK_N
13	NC	14	NC
15	HDMI_SCL	16	HDMI_SDAT
17	GND	18	5VHDMIPWR
19	HDMI_HPD		

## Internal Connectors

### BIOS Pin Header

Connector type: 2x3 6-pin header, 2.0mm pitch

Connector location: JP4

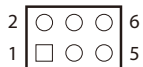

Pin	Definition	Pin	Definition
1	+3V3_SPI	2	GND
3	CS#_0	4	CLK_0
5	DO_0	6	DI_0

### SATA Connectors

Connector type: Standard Serial ATA 7P (1.27mm, SATA-M-180)

Connector location: SATA1 & SATA2

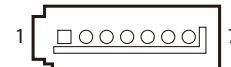

#### SATA1

Pin	Definition	Pin	Definition
1	GND	2	SATA_TXP2
3	SATA_TXN2	4	GND
5	SATA_RXN2	6	SATA_RXP2
7	GND		

#### SATA2

Pin	Definition	Pin	Definition
1	GND	2	SATA_TXP3
3	SATA_TXN3	4	GND
5	SATA_RXN3	6	SATA_RXP3
7	GND		

## SATA Power Connectors

Connector type: 1x2 2-pin Wafer, 2.0mm pitch  
Connector location: CN10 and CN11

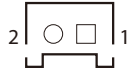

Pin	Definition
1	VCC5
2	GND

## GPIO Pin Header

Connector type: 2x5 10-pin header, 2.0mm pitch  
Connector location: CN9

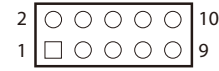

Pin	Definition	Pin	Definition
1	GPIO_PWR	2	GND
3	GPO0_OUT	4	GPIO_IN
5	GPO1_OUT	6	GPI1_IN
7	GPO2_OUT	8	GPI2_IN
9	GPO3_OUT	10	GPI3_IN

## System Reset

Connector type: 1x2 2-pin header, 2.0mm pitch

Connector location: JP1



Pin	Definition
1	SYSRESETN
2	GND

## Port 80 Connector

Connector type: 1x10 10-pin header, 1.0mm pitch

Connector location: J1



Pin	Definition	Pin	Definition
1	GND	2	PLTRST#_BUFF_1
3	CLKOUT_LPC1	4	ESPI_CS0#
5	ESPI_IO3	6	ESPI_IO2
7	ESPI_IO1	8	ESPI_IO0
9	SERIRQ	10	VCC3

### COM1 Connector (Full RS232/422/485)

Connector type: 1x10 10-pin header, 1.0mm pitch

Connector location: COM1



Pin	Definition	Pin	Definition
1	SP1_DCD	2	SP1_RXD
3	SP1_TXD	4	SP1_DTR
5	ISO_GND	6	SP1_DSR
7	SP1_RTS	8	SP1_CTS
9	SP1_RI	10	ISO_GND

### COM2 Connector (Full RS232/422/485)

Connector type: 1x10 10-pin header, 1.0mm pitch

Connector location: COM2



Pin	Definition	Pin	Definition
1	SP2_DCD	2	SP2_RXD
3	SP2_TXD	4	SP2_DTR
5	ISO_GND	6	SP2_DSR
7	SP2_RTS	8	SP2_CTS
9	SP2_RI	10	ISO_GND

### COM3 Connector (Full RS232)

Connector type: 1x10 10-pin header, 1.0mm pitch

Connector location: COM3



Pin	Definition	Pin	Definition
1	COM_DCD#3	2	COM_RXD3
3	COM_TXD3	4	COM_DTR#3
5	GND	6	COM_DSR#3
7	COM_RTS#3	8	COM_CTS#3
9	COM_RI#3	10	GND

### COM4 Connector (Full RS232)

Connector type: 1x10 10-pin header, 1.0mm pitch

Connector location: COM4



Pin	Definition	Pin	Definition
1	COM_DCD#4	2	COM_RXD4
3	COM_TXD4	4	COM_DTR#4
5	GND	6	COM_DSR#4
7	COM_RTS#4	8	COM_CTS#4
9	COM_RI#4	10	GND

## Speaker-out Header

Connector type: 1x5 5-pin header, 2.0mm pitch

Connector location: SPK1



Pin	Definition	Pin	Definition
1	OUT-LR+_C	2	OUT-LR-_C
3	AGND	4	OUT-RR+_C
5	OUT-RR-_C		

## Mic-in Header

Connector type: 1x4 4-pin header, 2.0mm pitch

Connector location: MIC1



Pin	Definition	Pin	Definition
1	MIC_OUT-L	2	AGND
3	MIC_JD	4	MIC_OUT-R



## Line-out Header

Connector type: 1x4 4-pin header, 2.0mm pitch

Connector location: OUT1



Pin	Definition	Pin	Definition
1	LINE_OUT_LC	2	AGND
3	LINEOUT_JD	4	LINE_OUT_RC

## Line-in Header

Connector type: 1x4 4-pin header, 2.0mm pitch

Connector location: IN1



Pin	Definition	Pin	Definition
1	LINE1-L1	2	AGND
3	LINEIN_JD	4	LINE1-R1

## RTC Battery Connector

Connector location: BAT1

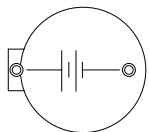

Pin	Definition
1	3V_BAT1
2	GND

## SMBus Header

Connector type: 1x3 3-pin header, 2.54mm pitch

Connector location: JP2



Pin	Definition
1	SMB_CLK
2	SMB_DATA
3	GND

## LED Pin Header

Connector type: 2x7 14-pin header, 2.0mm pitch

Connector location: JP7

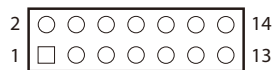

Pin	Definition	Pin	Definition
1	TX1_P	2	COM1_TXLEDN
3	RX1_P	4	COM1_RXLEDN
5	TX2_P	6	COM2_TXLEDN
7	RX2_P	8	COM2_RXLEDN
9	SIO_GP81LED_P	10	SIO_GP81
11	SIO_GP80LED_P	12	SIO_GP80
13	LAN2_ACT#_LED_P	14	LAN2LEDACTN

## System Fan Box Header

Connector type: 1x4 4-pin header JST, 2.0mm pitch

Connector location: SYSF1

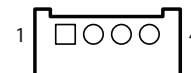

Pin	Definition	Pin	Definition
1	GND	2	VCC12
3	FAN_TAC2	4	FAN_CTL2

## Mini-PCIe Connector (PCIe/GSM/USB 2.0)

Connector location: CN4

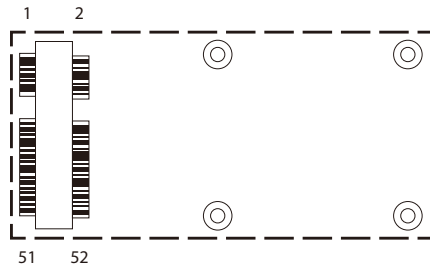

Pin	Definition	Pin	Definition
1	I_WAKEN	2	3VSBMINIPCIE
3	N/A	4	GND
5	N/A	6	1V5MINIPCIE
7	SRCCLKREQ8N	8	UIM_PWR
9	GND	10	UIM_DATA
11	I_CLKOUTPCIEN8	12	UIM_CLK
13	I_CLKOUTPCIEP8	14	UIM_RESET
15	GND	16	UIM_VPP
17	N/A	18	GND
19	N/A	20	MINICARD2DIS#
21	GND	22	MINIPCIEPERSTN
23	I_PCIERXN11	24	3VSBMINIPCIE
25	I_PCIERXP11	26	GND

Pin	Definition	Pin	Definition
27	GND	28	1V5MINIPCIE
29	GND	30	SMB_CLK
31	PCIETXN11	32	SMB_DATA
33	PCIETXP11	34	GND
35	GND	36	I_USB2N8
37	GND	38	I_USB2P8
39	3VSBMINIPCIE	40	GND
41	3VSBMINIPCIE	42	N/A
43	GND	44	N/A
45	N/A	46	N/A
47	N/A	48	1V5MINIPCIE
49	N/A	50	GND
51	NC	52	3VSBMINIPCIE

## NGFF M.2 B-Key Connector (USB 3.0/USB 2.0)

Connector location: CN5

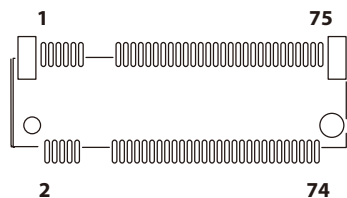

Pin	Definition	Pin	Definition
1	CONFIG_3	2	3VSB
3	GND	4	3VSB
5	GND	6	POWEROFF
7	S_USB2P_2	8	M2LTEDISL
9	S_USB2N_2	10	NC
11	GND	12	
13		14	
15		16	
17		18	
19		20	NC
21	CONFIG_0	22	NC
23	I_WAKEN	24	NC
25	NC	26	NC
27	GND	28	NC
29	H_USB31_RXN7	30	UIM_RESET
31	H_USB31_RXP7	32	UIM_CLK
33	GND	34	UIM_DATA
35	H_USB31_TXN7	36	UIM_PWR
37	H_USB31_TXP7	38	NC

Pin	Definition	Pin	Definition
39	GND	40	NC
41	NC	42	NC
43	NC	44	NC
45	GND	46	NC
47	NC	48	NC
49	NC	50	M2_B_PERST
51	GND	52	NC
53	NC	54	M2_B_PEWAKE
55	NC	56	NC
57	GND	58	NC
59	NC	60	NC
61	NC	62	NC
63	NC	64	NC
65	NC	66	NC
67	M2LTERSTL	68	NC
69	M2LTECONFIG1	70	3VSB
71	GND	72	3VSB
73	GND	74	3VSB
75	M2LTECONFIG2		

## NGFF M.2 M-Key Connector (SATA/PCIe x1)

Connector location: CN6

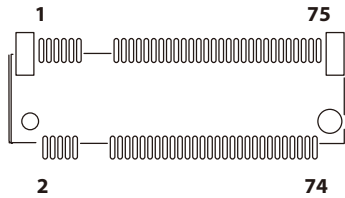

Pin	Definition	Pin	Definition
1	GND	2	3VSB
3	3VSB	4	3VSB
5	H_PCIERXN20	6	NC
7	H_PCIERP20	8	NC
9	GND	10	DSS#_1(LED)
11	H_PCIETXN20	12	3VSB
13	H_PCIETXP20	14	3VSB
15	GND	16	3VSB
17	H_PCIERXN19	18	3VSB
19	H_PCIERP19	20	NC
21	GND	22	NC
23	H_PCIETXN19	24	NC
25	H_PCIETXP19	26	NC
27	GND	28	NC
29	H_PCIERXN18	30	NC
31	H_PCIERP18	32	NC
33	GND	34	NC
35	H_PCIETXN18	36	NC
37	H_PCIETXP18	38	DEVS_LP_0

Pin	Definition	Pin	Definition
39	GND	40	NC
41	H_PCIESATARXN17	42	NC
43	H_PCIESATARP17	44	NC
45	GND	46	NC
47	H_PCIESATATXN17	48	NC
49	H_PCIESATATXP17	50	M2_PLTRSTN1
51	GND	52	SRCCLKREQ3N
53	I_CLKOUTPCIE3	54	I_WAKEN
55	I_CLKOUTPCIEP3	56	NC
57	GND	58	NC
59		60	
61		62	
63		64	
65		66	
67	NC	68	I_SUSCLK2
69	PEDET_1(VCC3)	70	3VSB
71	M2_SATADETL	72	3VSB
73	GND	74	3VSB
75	GND		

## PCIe x16 Slot

Connector location: PCIE



Pin	Definition	Pin	Definition
A1	PCIE_PRSTN1	B1	VCC12
A2	VCC12	B2	VCC12
A3	VCC12	B3	VCC12
A4	GND	B4	GND
A5	PCIEX16_TCK	B5	PCIE_SMCLK
A6	PCIEX16_TDI	B6	PCIE_SMDAT
A7	PCIEX16_TDO	B7	GND
A8	PCIEX16_TMS	B8	VCC3
A9	VCC3	B9	PCIEX16_TRST#
A10	VCC3	B10	3VSB
A11	PCIEX16PLTRSTN	B11	3VSB
A12	GND	B12	FAN_TAC2(NC)
A13	I_CLKOUTPCIEP9	B13	GND
A14	I_CLKOUTPCIEP9	B14	PEG_TXP0_C
A15	GND	B15	PEG_TXN0_C
A16	PEG_RXP0	B16	GND
A17	PEG_RXN0	B17	PRSTN2#_1_C
A18	GND	B18	GND

Pin	Definition	Pin	Definition
A19	FAN_CTL2(NC)	B19	PEG_TXP1_C
A20	GND	B20	PEG_TXN1_C
A21	PEG_RXP1	B21	GND
A22	PEG_RXN1	B22	GND
A23	GND	B23	PEG_TXP2_C
A24	GND	B24	PEG_TXN2_C
A25	PEG_RXP2	B25	GND
A26	PEG_RXN2	B26	GND
A27	GND	B27	PEG_TXP3_C
A28	GND	B28	PEG_TXN3_C
A29	PEG_RXP3	B29	GND
A30	PEG_RXN3	B30	NC
A31	GND	B31	PRSTN2#_2
A32	NC	B32	GND
A33	NC	B33	PEG_TXP4_C
A34	GND	B34	PEG_TXN4_C
A35	PEG_RXP4	B35	GND
A36	PEG_RXN4	B36	GND

Pin	Definition	Pin	Definition
A37	GND	B37	PEG_TXP5_C
A38	GND	B38	PEG_TXN5_C
A39	PEG_RXP5	B39	GND
A40	PEG_RXN5	B40	GND
A41	GND	B41	PEG_TXP6_C
A42	GND	B42	PEG_TXN6_C
A43	PEG_RXP6	B43	GND
A44	PEG_RXN6	B44	GND
A45	GND	B45	PEG_TXP7_C
A46	GND	B46	PEG_TXN7_C
A47	PEG_RXP7	B47	GND
A48	PEG_RXN7	B48	PRSNT2#_3
A49	GND	B49	GND
A50	NC	B50	PEG_TXP8_C
A51	GND	B51	PEG_TXN8_C
A52	PEG_RXP8	B52	GND
A53	PEG_RXN8	B53	GND
A54	GND	B54	PEG_TXP9_C
A55	GND	B55	PEG_TXN9_C
A56	PEG_RXP9	B56	GND
A57	PEG_RXN9	B57	GND
A58	GND	B58	PEG_TXP10_C
A59	GND	B59	PEG_TXN10_C

Pin	Definition	Pin	Definition
A60	PEG_RXP10	B60	GND
A61	PEG_RXN10	B61	GND
A62	GND	B62	PEG_TXP11_C
A63	GND	B63	PEG_TXN11_C
A64	PEG_RXP11	B64	GND
A65	PEG_RXN11	B65	GND
A66	GND	B66	PEG_TXP12_C
A67	GND	B67	PEG_TXN12_C
A68	PEG_RXP12	B68	GND
A69	PEG_RXN12	B69	GND
A70	GND	B70	PEG_TXP13_C
A71	GND	B71	PEG_TXN13_C
A72	PEG_RXP13	B72	GND
A73	PEG_RXN13	B73	GND
A74	GND	B74	PEG_TXP14_C
A75	GND	B75	PEG_TXN14_C
A76	PEG_RXP14	B76	GND
A77	PEG_RXN14	B77	GND
A78	GND	B78	PEG_TXP15_C
A79	GND	B79	PEG_TXN15_C
A80	PEG_RXP15	B80	GND
A81	PEG_RXN15	B81	PRSNT2#_4
A82	GND	B82	NC



## CHAPTER 3: SYSTEM SETUP

### Removing the Top Cover



Prior to removing the chassis cover, make sure the unit's power is off and disconnected from the power sources to prevent electric shock or system damage.

1. Remove the 4 screws on the sides.



2. Remove the 4 screws on the top.

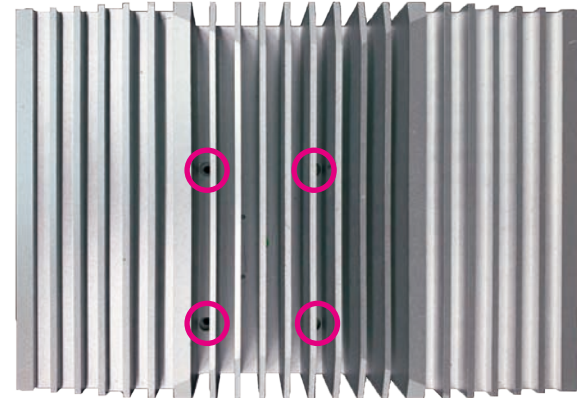

3. With the screws removed, lift up the cover and remove it from the chassis.



4. When reinstalling the top cover to the system, ensure that the 4 mounting holes on the top cover is aligned correctly to the four copper standoffs around the CPU socket.

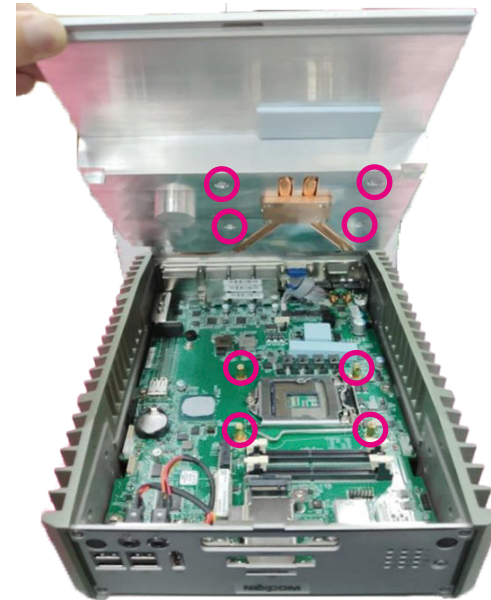

## Removing the Bottom Cover

1. Locate the 6 screws on the bottom cover.

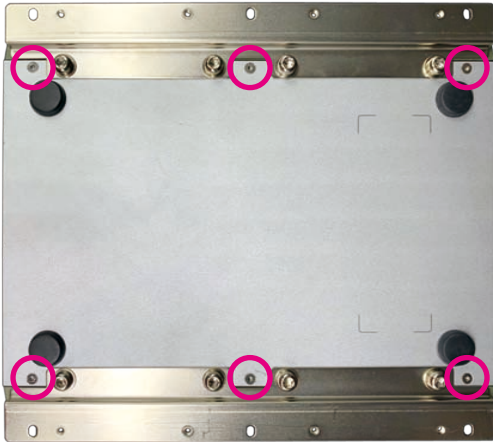

2. Remove the screws then lift up the bottom cover and remove it from the chassis.

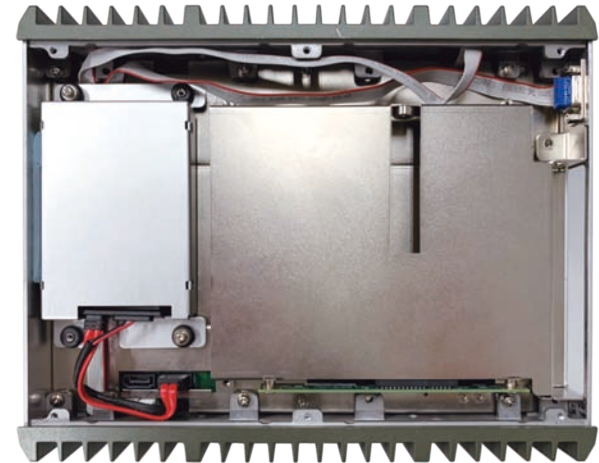

## Installing a CPU

1. Locate the CPU socket on the board. Unlock the socket by pushing the load lever down, moving it sideways until it is released from the retention tab.

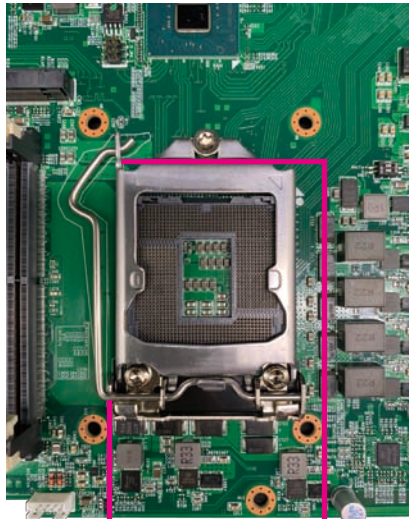

Load Lever

Retention Tab

2. Lift the load lever up to open the CPU retention bracket.

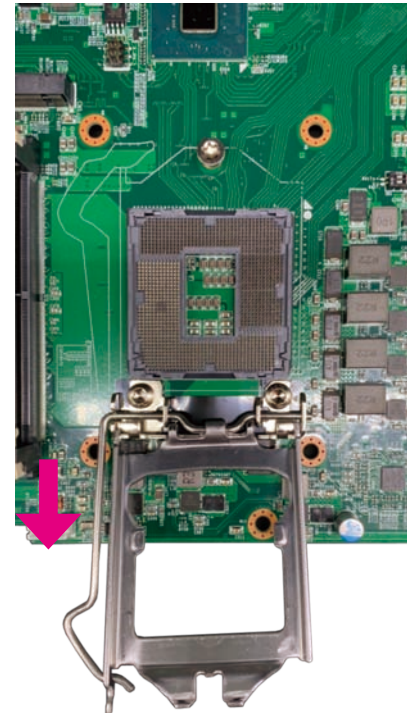

3. Insert the CPU into the socket. The triangular edge on the CPU must align with the corner of the CPU socket shown on the photo.

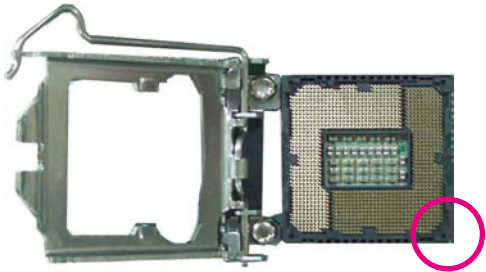

The CPU's notch will at the same time fit into the socket's alignment key.

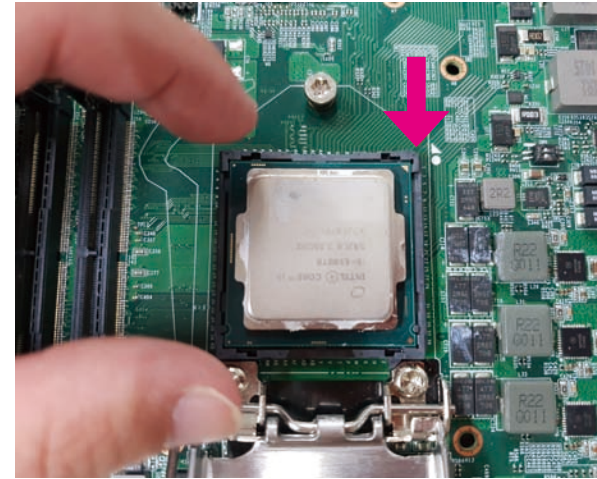
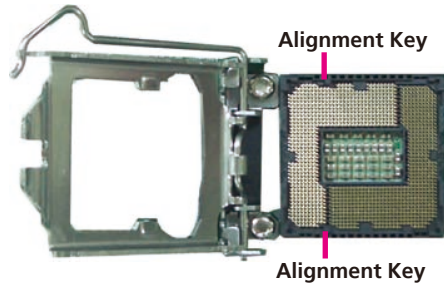

- Handle the CPU by its edges and avoid touching the pins.
- The CPU will fit in only one orientation and can easily be inserted without exerting any force.

4. With the CPU installed, close the retention bracket and then hook the load lever under the retention tab. Ensure that the notch on the retention bracket is slid under the screw before lowering the load lever as shown below.

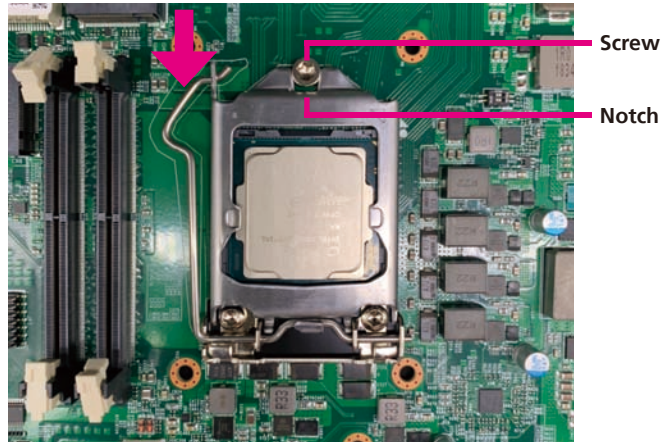

Do not force the CPU into the socket. Forcing the CPU into the socket may bend the pins and damage the CPU.



## Installing a Mini-PCle Module

1. Locate the mini-PCle slot on the board.

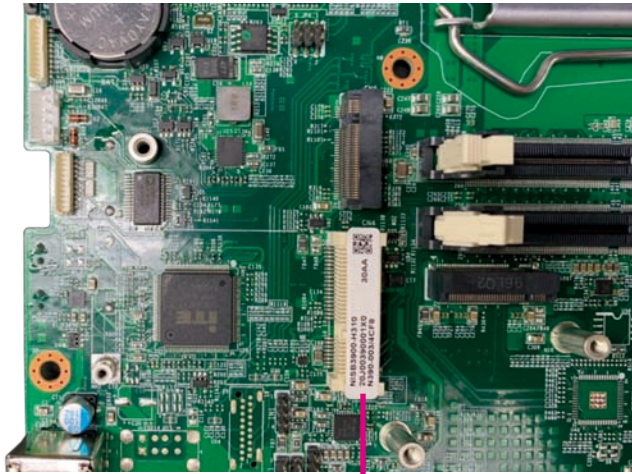

Mini-PCle Slot

2. Insert the module into the mini-PCle slot at a 30-degree angle.

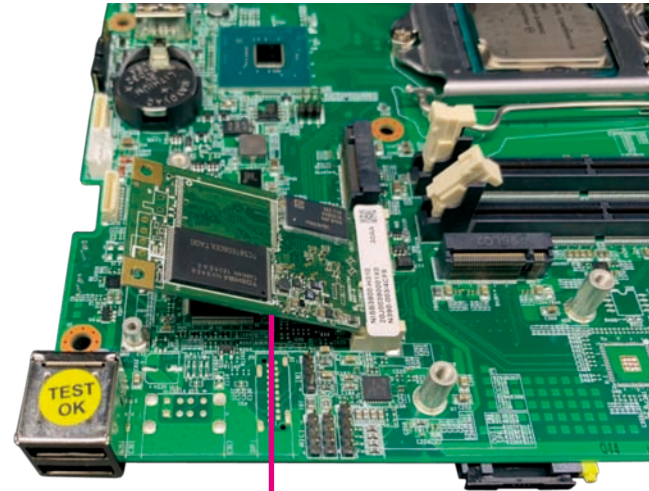

Mini-PCle Module

3. Push the module down and then secure it with a mounting screw.

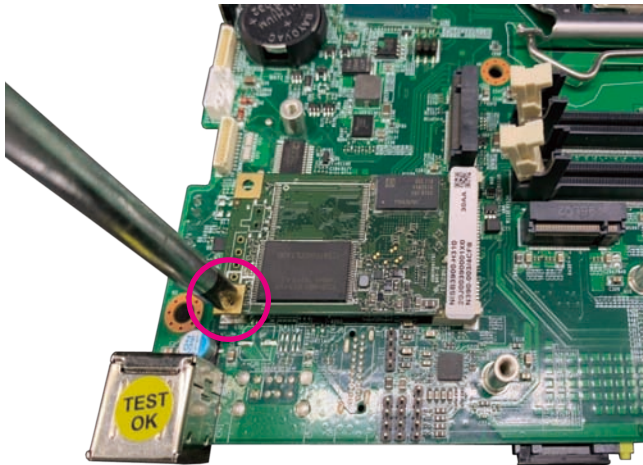



## Installing an M.2 Module (Internal)

1. Locate the m.2 slot on the board.

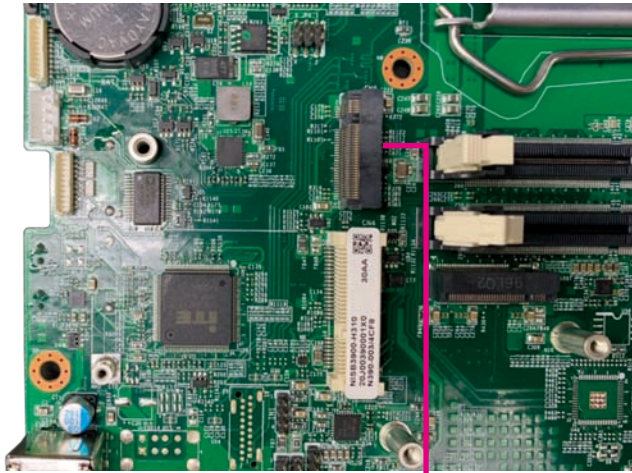

M.2 Slot

2. Insert the M.2 module into the slot at a 30-degree angle.



M.2 Module

3. Push the module down and then secure it with a mounting screw.

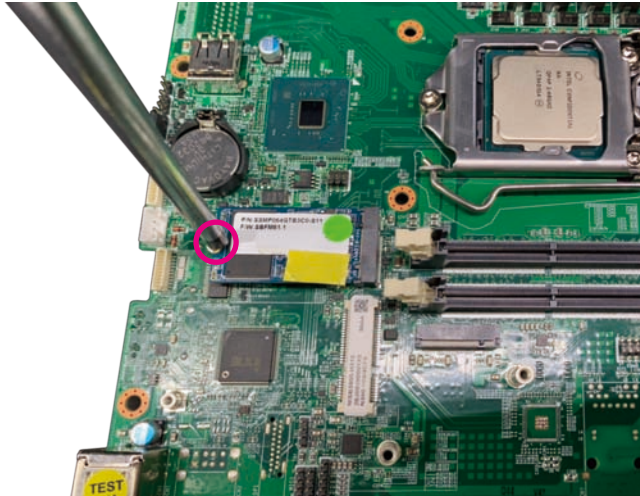

## Installing a SO-DIMM Memory Module



Remove the top cover before installing a SO-DIMM module.

1. Locate the SO-DIMM sockets and release the locks.

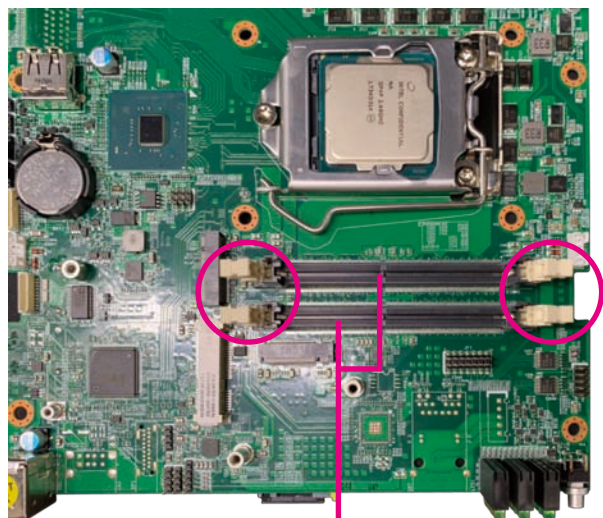

SO-DIMM  
Sockets

2. Insert the SO-DIMM module into the socket and apply even pressure to both ends of the module until it slips into the socket. While pushing the module into position, the locks will close automatically.

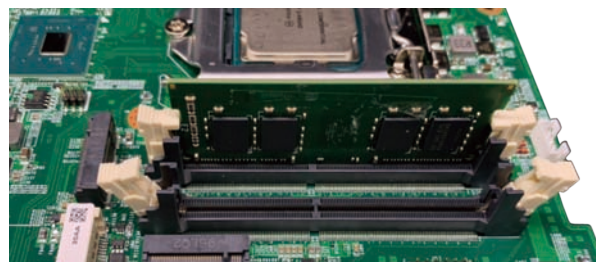
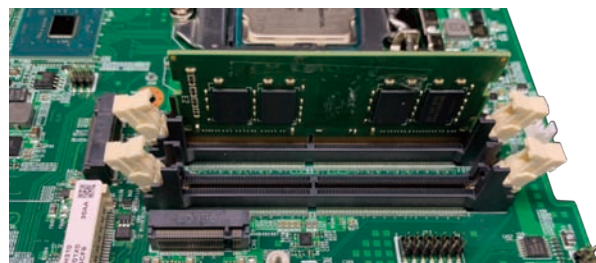

## Installing a SIM Card

1. Locate the SIM card holder on the front panel.



2. Push the yellow button on the SIM card holder. The SIM card holder will eject. Then place the SIM card into the SIM card holder and insert it back to the original position.

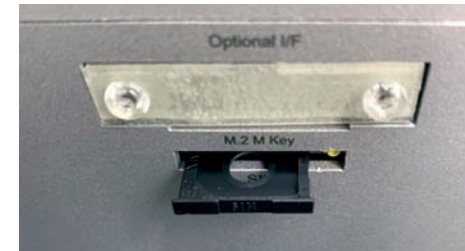

## Installing an M.2 Card (External)

1. Locate the M.2 bracket cover on the front panel and unscrew the screws securing it. Then remove the bracket from the system.
2. Slide the M.2 module to the mounting plate on the M.2 bracket and secure it with a screw.



M.2 Bracket



3. Install the M.2 bracket back to its original position. Make sure the connector on the edge of the module is plugged firmly into the connector on the board.





## Installing an Internal SATA Storage Drive (NISE 3900E/P2/P2E/E2/H310)

1. With the bottom cover of the chassis removed, unscrew the screws securing the storage bracket and lift it up.
2. Place the storage drive into the bracket and secure the drive with screws.

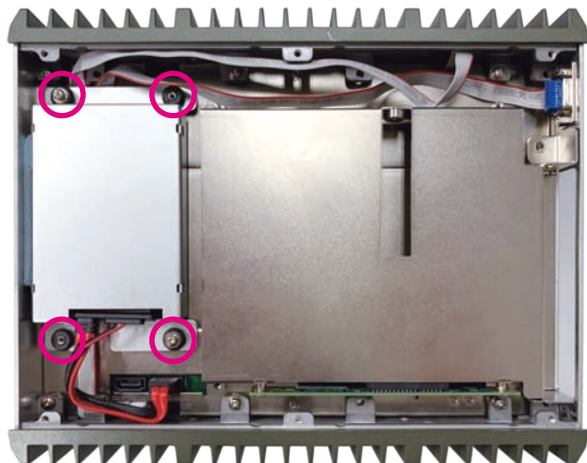

3. Connect the SATA connector to the storage drive and secure the storage bracket back to its original location. If the SATA power and data cables are higher than the chassis, please rearrange the cables so that they are inside the chassis, as shown by the dotted line below.

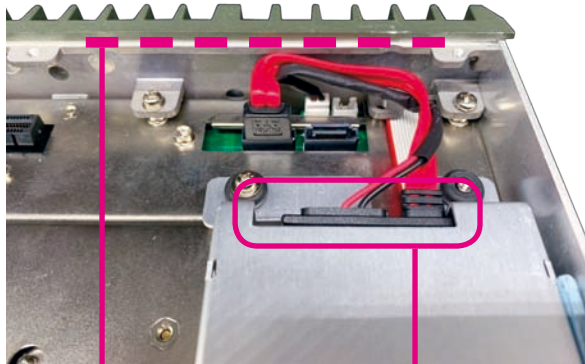

Fit cables below this dotted line

SATA Connector



## Installing an External SATA Storage Drive (NISE 3900R)

1. On the rear side of NISE 3900R, loosen the screws on the SSD/HDD drive bay and slide the drive bay out.
2. Insert the storage drive into the drive bay with the SATA data and power connector facing towards the end. Then, while supporting the storage drive, turn the bracket to the other side. From the outside of the storage bracket, secure the drive in place with screws.

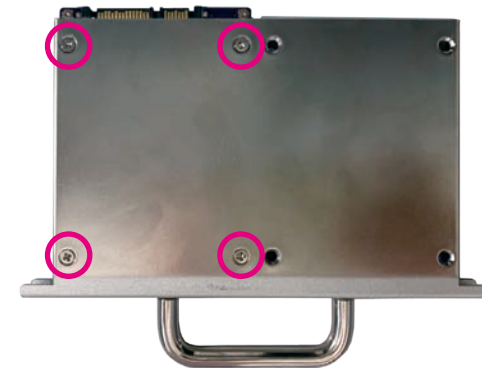

3. Insert the drive bay back in the SSD/HDD slot and tighten the screws to secure it in place.



## Wallmount Brackets

The wallmount brackets provide a convenient and economical way of mounting the system on the wall.

1. The mounting holes are located at the bottom of the system. Secure the brackets on each side of the system using the provided mounting screws.
2. Secure the brackets to the system by inserting four retention screws (M6\*10mm) into each bracket.

Secure the bracket to the system

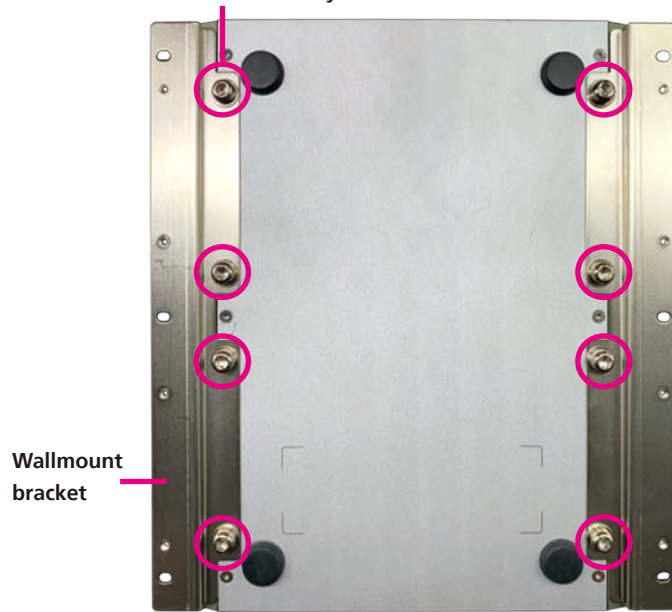

3. Now mount the system on the wall by fastening screws through the bracket's mounting holes.

Fasten screws to mount the system to the wall



# CHAPTER 4: BIOS SETUP

This chapter describes how to use the BIOS setup program for the NISE 3900 series. The BIOS screens provided in this chapter are for reference only and may change if the BIOS is updated in the future.

To check for the latest updates and revisions, visit the NEXCOM website at [www.nexcom.com.tw](http://www.nexcom.com.tw).

## About BIOS Setup

The BIOS (Basic Input and Output System) Setup program is a menu driven utility that enables you to make changes to the system configuration and tailor your system to suit your individual work needs. It is a ROM-based configuration utility that displays the system's configuration status and provides you with a tool to set system parameters.

These parameters are stored in non-volatile battery-backed-up CMOS RAM that saves this information even when the power is turned off. When the system is turned back on, the system is configured with the values found in CMOS.

With easy-to-use pull down menus, you can configure such items as:

- Hard drives, diskette drives, and peripherals
- Video display type and display options
- Password protection from unauthorized use
- Power management features

The settings made in the setup program affect how the computer performs. It is important, therefore, first to try to understand all the setup options, and second, to make settings appropriate for the way you use the computer.

## When to Configure the BIOS

- This program should be executed under the following conditions:
  - When changing the system configuration
  - When a configuration error is detected by the system and you are prompted to make changes to the setup program
  - When resetting the system clock
  - When redefining the communication ports to prevent any conflicts
  - When making changes to the Power Management configuration
  - When changing the password or making other changes to the security setup

Normally, CMOS setup is needed when the system hardware is not consistent with the information contained in the CMOS RAM, whenever the CMOS RAM has lost power, or the system features need to be changed.

## Default Configuration

Most of the configuration settings are either predefined according to the Load Optimal Defaults settings which are stored in the BIOS or are automatically detected and configured without requiring any actions. There are a few settings that you may need to change depending on your system configuration.

## Entering Setup











When the system is powered on, the BIOS will enter the Power-On Self Test (POST) routines. These routines perform various diagnostic checks; if an error is encountered, the error will be reported in one of two different ways:

- If the error occurs before the display device is initialized, a series of beeps will be transmitted.
- If the error occurs after the display device is initialized, the screen will display the error message.

Powering on the computer and immediately pressing <Del> allows you to enter Setup.

Press the  key to enter Setup:

## Legends

Key	Function
	Moves the highlight left or right to select a menu.
	Moves the highlight up or down between sub-menus or fields.
	Exits the BIOS Setup Utility.
	Scrolls forward through the values or options of the highlighted field.
	Scrolls backward through the values or options of the highlighted field.
	Selects a field.
	Displays General Help.
	Load previous values.
	Load optimized default values.
	Saves and exits the Setup program.
	Press <Enter> to enter the highlighted sub-menu.

### Scroll Bar

When a scroll bar appears to the right of the setup screen, it indicates that there are more available fields not shown on the screen. Use the up and down arrow keys to scroll through all the available fields.

### Submenu

When “▶” appears on the left of a particular field, it indicates that a submenu which contains additional options are available for that field. To display the submenu, move the highlight to that field and press  .

## BIOS Setup Utility

Once you enter the AMI BIOS Setup Utility, the Main Menu will appear on the screen. The main menu allows you to select from several setup functions and one exit. Use arrow keys to select among the items and press  to accept or enter the submenu.

### Main

The Main menu is the first screen that you will see when you enter the BIOS Setup Utility.

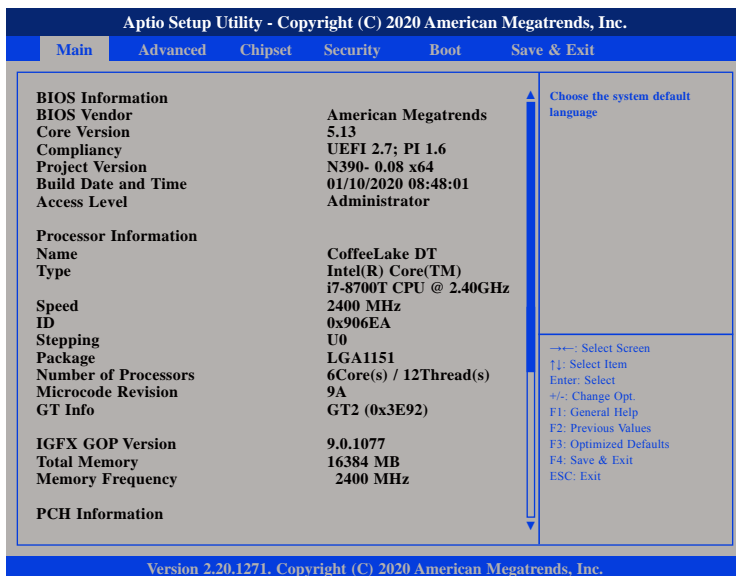

Aptio Setup Utility - Copyright (C) 2020 American Megatrends, Inc.					
Main	Advanced	Chipset	Security	Boot	Save & Exit
<b>BIOS Information</b>					
BIOS Vendor	American Megatrends				
Core Version	5.13				
Compliance	UEFI 2.7; PI 1.6				
Project Version	N390- 0.08 x64				
Build Date and Time	01/10/2020 08:48:01				
Access Level	Administrator				
<b>Processor Information</b>					
Name	CoffeeLake DT				
Type	Intel(R) Core(TM) i7-8700T CPU @ 2.40GHz				
Speed	2400 MHz				
ID	0x906EA				
Stepping	U0				
Package	LGA1151				
Number of Processors	6Core(s) / 12Thread(s)				
Microcode Revision	9A				
GT Info	GT2 (0x3E92)				
<b>IGFX GOP Version</b>					
Total Memory	9.0.1077				
Memory Frequency	16384 MB				
	2400 MHz				
<b>PCH Information</b>					
Name	CNL PCH-H				
PCH SKU	Q370				
Stepping	B0				
<b>ME FW Version</b>					
ME Firmware SKU	12.0.22.1310				
	Corporate SKU				
<b>System Language</b>					
	[English]				
<b>System Date</b>					
System Time	[Thu 02/27/2020]				
	[09:58:08]				
Version 2.20.1271. Copyright (C) 2020 American Megatrends, Inc.					



Aptio Setup Utility - Copyright (C) 2020 American Megatrends, Inc.					
Main	Advanced	Chipset	Security	Boot	Save & Exit
<b>Speed</b>					
	2400 MHz				
<b>ID</b>					
	0x906EA				
<b>Stepping</b>					
	U0				
<b>Package</b>					
	LGA1151				
<b>Number of Processors</b>					
	6Core(s) / 12Thread(s)				
<b>Microcode Revision</b>					
	9A				
<b>GT Info</b>					
	GT2 (0x3E92)				
<b>IGFX GOP Version</b>					
	9.0.1077				
<b>Total Memory</b>					
	16384 MB				
<b>Memory Frequency</b>					
	2400 MHz				
<b>PCH Information</b>					
Name					
	CNL PCH-H				
PCH SKU					
	Q370				
Stepping					
	B0				
<b>ME FW Version</b>					
	12.0.22.1310				
<b>ME Firmware SKU</b>					
	Corporate SKU				
<b>System Language</b>					
	[English]				
<b>System Date</b>					
System Time	[Thu 02/27/2020]				
	[09:58:08]				
Version 2.20.1271. Copyright (C) 2020 American Megatrends, Inc.					

### System Language

Selects the language of the system.

### System Date

The date format is <day>, <month>, <date>, <year>. Day displays a day, from Monday to Sunday. Month displays the month, from January to December. Date displays the date, from 1 to 31. Year displays the year, from 1999 to 2099.

### System Time

The time format is <hour>, <minute>, <second>. The time is based on the 24-hour military-time clock. For example, 1 p.m. is 13:00:00. Hour displays hours from 00 to 23. Minute displays minutes from 00 to 59. Second displays seconds from 00 to 59.

## Advanced

The Advanced menu allows you to configure your system for basic operation. Some entries are defaults required by the system board, while others, if enabled, will improve the performance of your system or let you set some features according to your preference.



Setting incorrect field values may cause the system to malfunction.



## CPU Configuration

This section is used to configure the CPU.

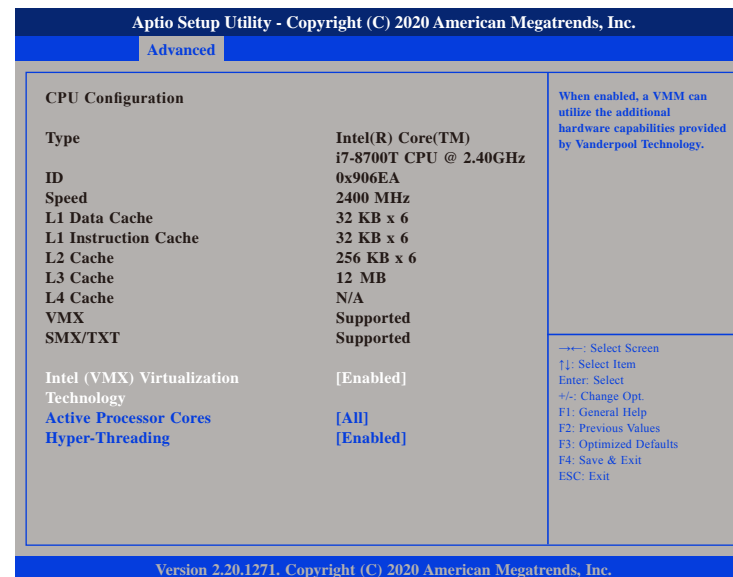

### Intel® (VMX) Virtualization Technology

Enables or disables Intel Virtualization technology.

### Active Processors Cores

Select the number of cores to enable in each processor package.

### Hyper-Threading

Enables or disables hyper-threading technology.



## Power & Performance

This section is used to configure the CPU power management features.

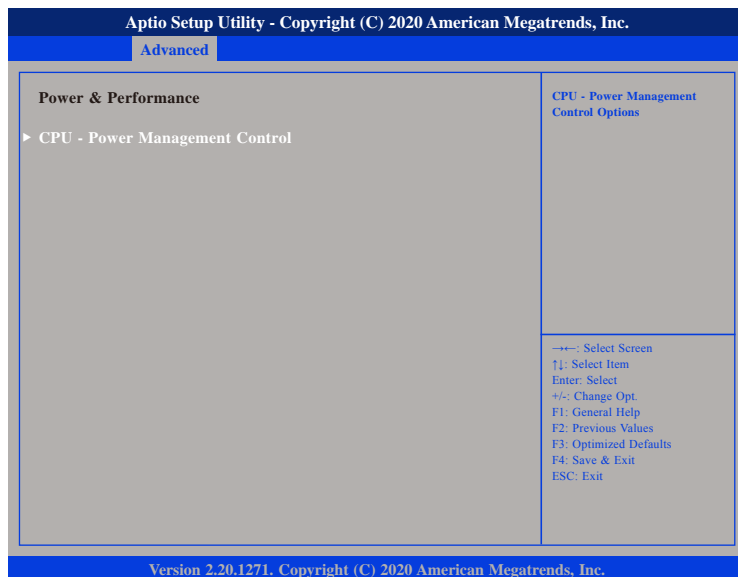

### CPU - Power Management Control

Enters the CPU - Power Management Control submenu.

## CPU - Power Management Control

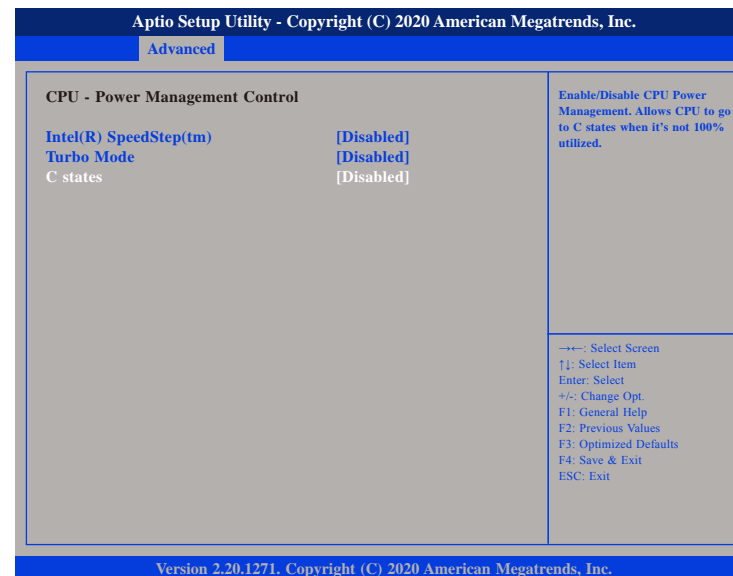

### Intel® SpeedStep™

Enables or disables Intel SpeedStep technology.

### Turbo Mode

Enables or disables turbo mode.

### C states

Enables or disables CPU C states support for power saving.

## Trusted Computing

This section is used to configure Trusted Platform Module (TPM) settings.

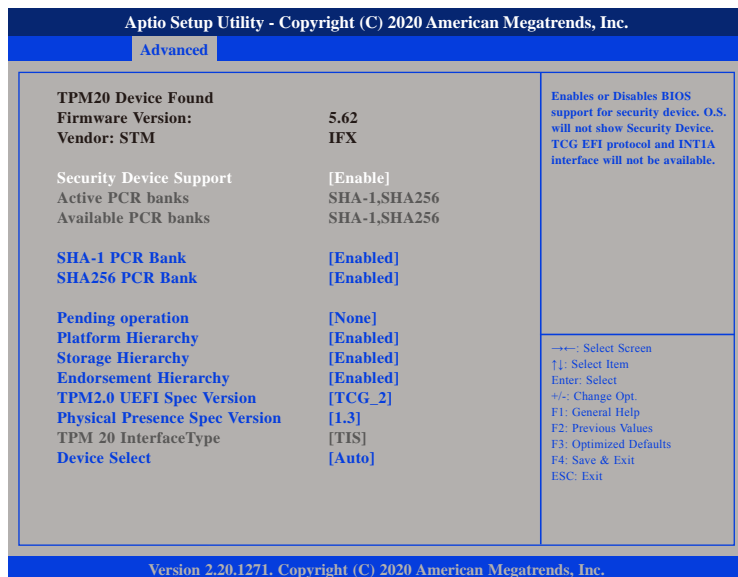

### Security Device Support

Enables or disables BIOS support for security device. O.S will not show Security Device. TCG EFI protocol and INT1A interface will not be available.

### SHA-1 PCR Bank

Enables or disables SHA-1 PCR Bank.

### SHA256 PCR Bank

Enables or disables SHA256 PCR Bank.

### Pending operation

Schedules an operation for the security device.

### Platform Hierarchy

Enables or disables platform hierarchy.

### Storage Hierarchy

Enables or disables storage hierarchy.

### Endorsement Hierarchy

Enables or disables endorsement hierarchy.

### TPM2.0 UEFI Spec Version

Configures the TPM2.0 UEFI spec version.

### Physical Presence Spec Version

Configures the physical presence spec version.

### Device Select

Configures the TPM version. TPM 1.2 will restrict support to TPM 1.2 devices and TPM 2.0 will restrict support to TPM 2.0 devices. Auto will support both TPM 1.2 and 2.0 devices with the default set to TPM 2.0 devices if not found, and TPM 1.2 devices will be enumerated.

## IT8786 Super IO Configuration

This section is used to configure the serial ports.

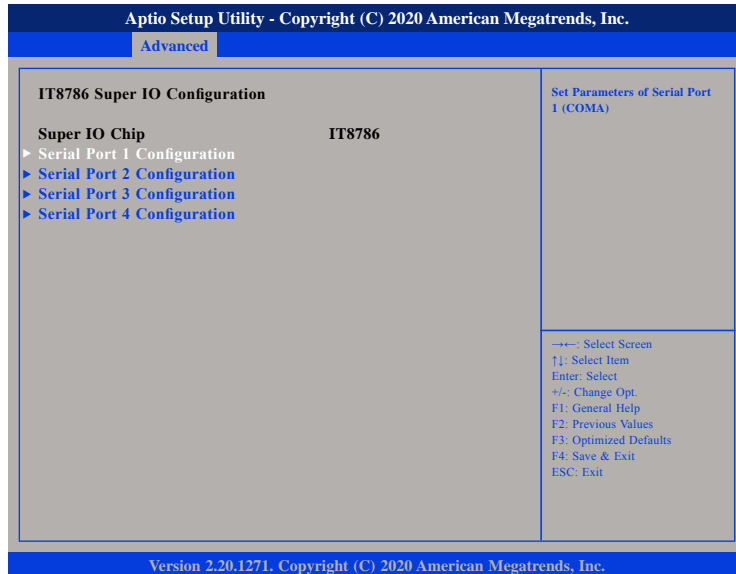

### Super IO Chip

Displays the Super I/O chip used on the board.

## Serial Port 1 Configuration

This section is used to configure serial port 1.

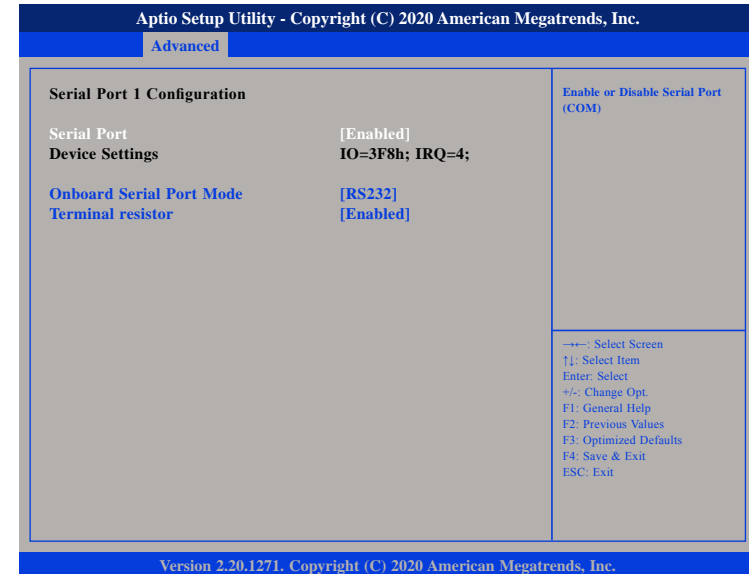

### Serial Port

Enables or disables the serial port.

### Onboard Serial Port Mode

Select this to change the serial port mode to RS232, RS422 or RS485.

### Terminal resistor

Enables or disables the terminal resistor.

## Serial Port 3 Configuration

This section is used to configure serial port 3.

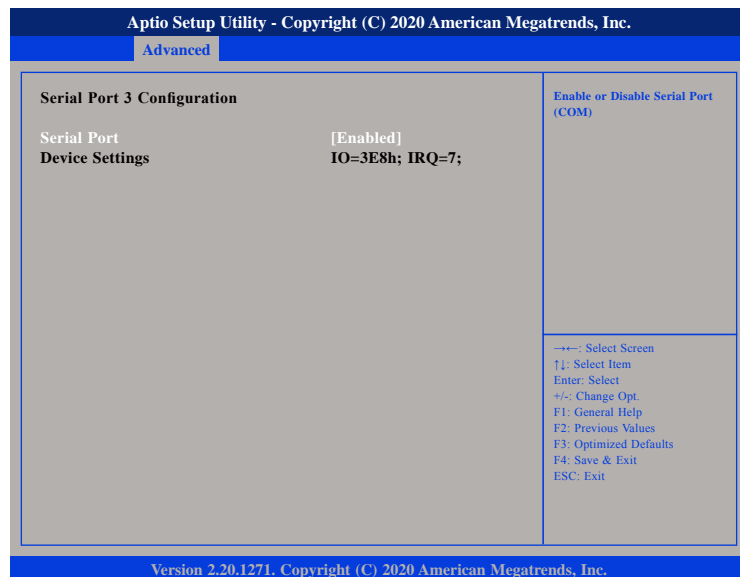

### Serial Port

Enables or disables the serial port.

## Serial Port 4 Configuration

This section is used to configure serial port 4.

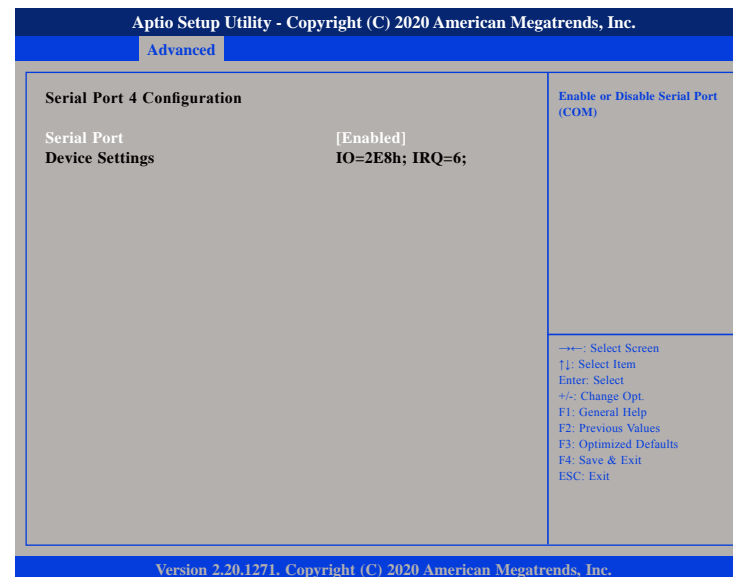

### Serial Port

Enables or disables the serial port.

## Hardware Monitor

This section is used to monitor hardware status such as temperature, fan speed and voltages.

**Aptio Setup Utility - Copyright (C) 2020 American Megatrends, Inc.**

**Advanced**

**Pe Health Status**

CPU Temperature	: +36 °c
System Temperature	: +31 °c
CPU Fan Speed	: N/A
System Fan Speed	: N/A
Vcore	: +0.880 V
+3V	: +3.283 V
+12V	: +11.946 V
+5V	: +5.087 V

→←: Select Screen  
 ↑↓: Select Item  
 Enter: Select  
 +/-: Change Opt.  
 F1: General Help  
 F2: Previous Values  
 F3: Optimized Defaults  
 F4: Save & Exit  
 ESC: Exit

Version 2.20.1271, Copyright (C) 2020 American Megatrends, Inc.

### CPU Temperature

Detects and displays the current CPU temperature.

### System Temperature

Detects and displays the current system temperature.

### Vcore to +5V

Detects and displays the output voltages.

## USB Configuration

This section is used to configure the USB.

**Aptio Setup Utility - Copyright (C) 2020 American Megatrends, Inc.**

**Advanced**

**USB Configuration**

USB Module Version: 21

USB Controllers:  
1 XHCI

USB Devices:  
1 Keyboard, 1 Mouse

Legacy USB Support: [Enabled]  
XHCI Hand-off: [Enabled]

USB hardware delays and time-outs:  
Device reset time-out: [20 sec]

→←: Select Screen  
 ↑↓: Select Item  
 Enter: Select  
 +/-: Change Opt.  
 F1: General Help  
 F2: Previous Values  
 F3: Optimized Defaults  
 F4: Save & Exit  
 ESC: Exit

Version 2.20.1271, Copyright (C) 2020 American Megatrends, Inc.

### Legacy USB Support

Enabled Enables Legacy USB.

Auto Disables support for Legacy when no USB devices are connected.

Disabled Keeps USB devices available only for EFI applications.

### XHCI Hand-off

This is a workaround for OSs that does not support XHCI hand-off. The XHCI ownership change should be claimed by the XHCI driver.

### Device reset time-out

Selects the USB mass storage device's start unit command timeout.

## Chipset

This section gives you functions to configure the system based on the specific features of the chipset. The chipset manages bus speeds and access to system memory resources.



### System Agent (SA) Configuration

System Agent (SA) parameters.

### PCH-IO Configuration

PCH-IO parameters.

## System Agent (SA) Configuration

This section is used to configure the System Agent (SA) configuration.

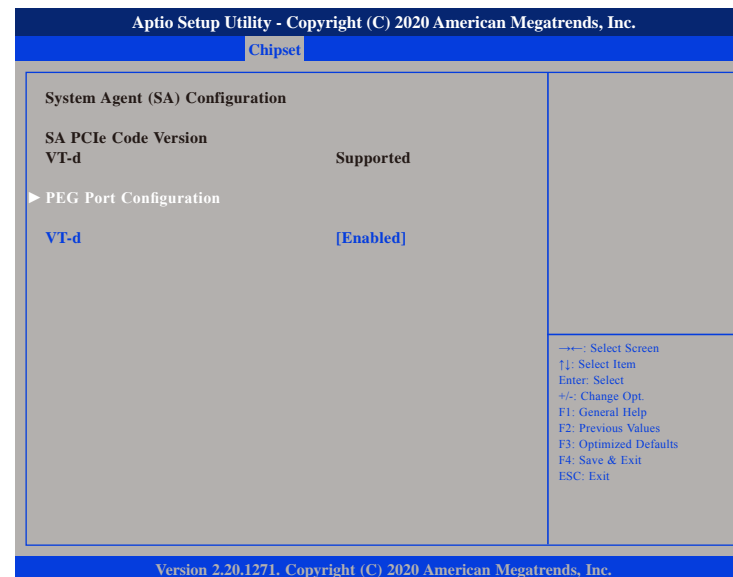

### VT-d

Enables or disables VT-d function on MCH.

## PEG Port Configuration

Aptio Setup Utility - Copyright (C) 2020 American Megatrends, Inc.	
Chipset	
<b>PEG Port Configuration</b>	Enable or Disable the Root Port
PEG 0:1:0	Not Present
Enable Root Port	[Auto]
Max Link Speed	[Auto]
PEG 0:1:1	Not Present
Enable Root Port	[Enabled]
Max Link Speed	[Auto]
PEG 0:1:2	Not Present
Enable Root Port	[Enabled]
Max Link Speed	[Auto]
←→: Select Screen ↑↓: Select Item Enter: Select +/-: Change Opt. F1: General Help F2: Previous Values F3: Optimized Defaults F4: Save & Exit ESC: Exit	
Version 2.20.1271. Copyright (C) 2020 American Megatrends, Inc.	

### Enable Root Port

Enables or disables the root port.

### Max Link Speed

Select the maximum link speed of the PEG device.

## PCH-IO Configuration

This section is used to configure PCH-IO configuration.

Aptio Setup Utility - Copyright (C) 2020 American Megatrends, Inc.	
Chipset	
<b>PCH-IO Configuration</b>	SATA Device Options Settings
▶ SATA And RST Configuration ▶ Security Configuration ▶ HD Audio Configuration	
PCH LAN Controller	[Enabled]
State After G3	[S0 State]
LAN2	[Enabled]
LAN3	[Enabled]
←→: Select Screen ↑↓: Select Item Enter: Select +/-: Change Opt. F1: General Help F2: Previous Values F3: Optimized Defaults F4: Save & Exit ESC: Exit	
Version 2.20.1271. Copyright (C) 2020 American Megatrends, Inc.	

### PCH LAN Controller

Enables or disables onboard NIC.

### State After G3

Configures the power state when power is re-applied after a power failure (G3 state).

### LAN2 and LAN3

Enables or disables LAN2 and LAN2 controllers.

## SATA And RST Configuration



### SATA Controller(s)

Enables or disables SATA device.

### SATA Mode Selection

Configures the SATA controller as AHCI mode or Intel RST Premium mode.

## Security Configuration



### RTC Memory Lock

Enables or disables bytes 38h-3Fh in the upper and lower 128-byte bank of RTC RAM.



## HD Audio Configuration

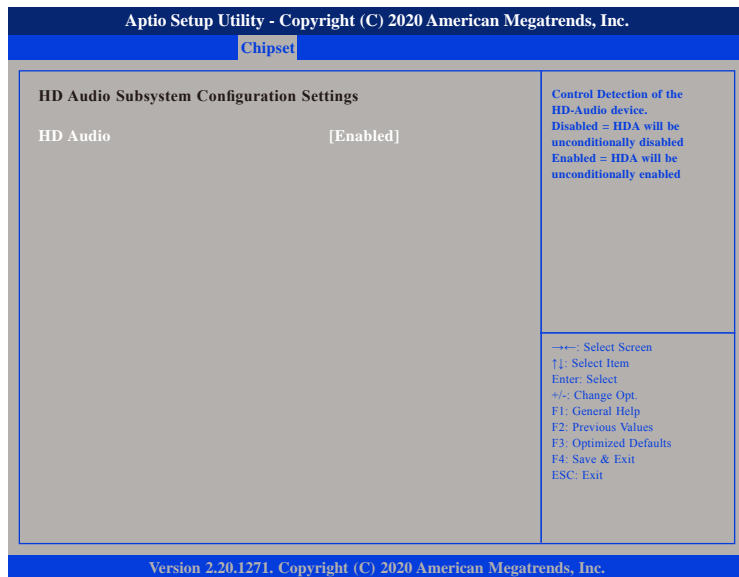

### HD Audio

Control detection of the HD audio device.

- Disabled HD audio will be unconditionally disabled.
- Enabled HD audio will be unconditionally enabled.

## Security

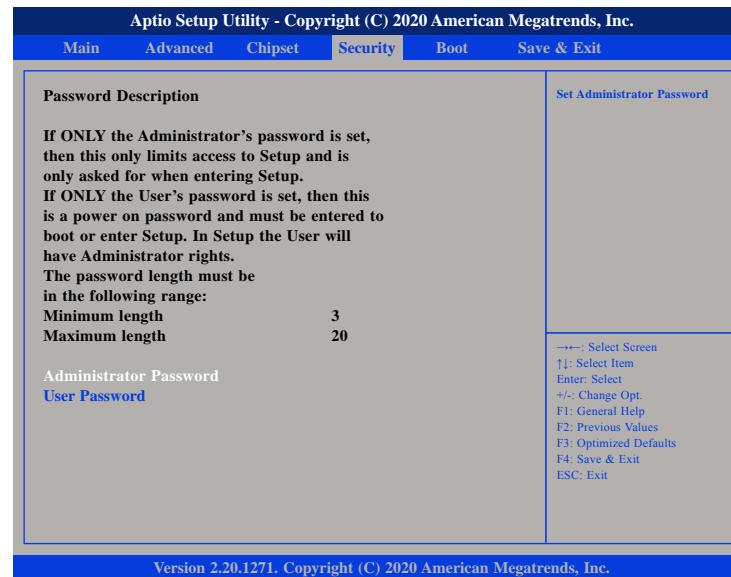

### Administrator Password

Select this to reconfigure the administrator's password.

### User Password

Select this to reconfigure the user's password.

## Boot



### Setup Prompt Timeout

Selects the number of seconds to wait for the setup activation key. 65535(0xFFFF) denotes indefinite waiting.

### Bootup NumLock State

This allows you to determine the default state of the numeric keypad. By default, the system boots up with NumLock on wherein the function of the numeric keypad is the number keys. When set to Off, the function of the numeric keypad is the arrow keys.

### Quiet Boot

Enabled            Displays OEM logo instead of the POST messages.  
 Disabled          Displays normal POST messages.

### Boot Option Priorities

Adjusts the boot sequence of the system. Boot Option #1 is the first boot device that the system will boot from, next will be #2 and so forth.

### Fast Boot

Enables or disables fast boot technology to speed up the system boot time. This is achieved by skipping specific tests during BIOS POST routine.

## Save & Exit



### Save Changes and Exit

To save the changes and exit the Setup utility, select this field then press <Enter>. A dialog box will appear. Confirm by selecting Yes. You can also press <F4> to save and exit Setup.

### Discard Changes and Exit

To exit the Setup utility without saving the changes, select this field then press <Enter>. You may be prompted to confirm again before exiting. You can also press <ESC> to exit without saving the changes.

### Save Changes and Reset

To save the changes and reset, select this field then press <Enter>. A dialog box will appear. Confirm by selecting Yes.

### Discard Changes and Reset

To exit the Setup utility and reset without saving the changes, select this field then press <Enter>. You may be prompted to confirm again before exiting.

### Save Changes

To save changes and continue configuring the BIOS, select this field then press <Enter>. A dialog box will appear. Confirm by selecting Yes.

### Discard Changes

To discard the changes, select this field then press <Enter>. A dialog box will appear. Confirm by selecting Yes to discard all changes made and restore the previously saved settings.

### Restore Defaults

To restore the BIOS to default settings, select this field then press <Enter>. A dialog box will appear. Confirm by selecting Yes.

### Save as User Defaults

To use the current configurations as user default settings for the BIOS, select this field then press <Enter>. A dialog box will appear. Confirm by selecting Yes.

### Restore User Defaults

To restore the BIOS to user default settings, select this field then press <Enter>. A dialog box will appear. Confirm by selecting Yes.

### Boot Override

To bypass the boot sequence from the Boot Option List and boot from a particular device, select the desired device and press <Enter>.