



NEXCOM International Co., Ltd.

Industrial Computing Solutions

Fan-less Computer

NISE 105/105A

User Manual

Contents

Preface

Copyright	iv
Disclaimer	iv
Acknowledgements	iv
Regulatory Compliance Statements	iv
Declaration of Conformity	iv
RoHS Compliance	v
Warranty and RMA	vi
Safety Information	viii
Installation Recommendations	viii
Safety Precautions	ix
Technical Support and Assistance	x
Conventions Used in this Manual	x
Global Service Contact Information	xi
Ordering Information	xiii

Chapter 1: Product Introduction

Overview	1
Key Features	1
Hardware Specifications	2
Knowing Your NISE 105	4
Front Panel	4
Rear Panel	5
Mechanical Dimensions	6

Chapter 2: Jumpers and Connectors

Before You Begin	7
Precautions	7
Jumper Settings	8
NISE 105 System Components	9
Locations of the Jumpers and Connectors for NISB 105	9
Jumpers	10
AT/ATX Pin Header	10
Connector Pin Definitions	11
External I/O Interfaces - Front Panel	11
USB 3.0 and USB 2.0 Port	11
DVI-I Connector	11
LAN1 and LAN2 Ports	12
CFast	13
Power Switch	13
External I/O Interfaces - Rear Panel	14
Audio Connectors	14
COM3 Port	14
COM4 Port	15
HDMI	15
USB 2.0 Port	16
Internal Connectors	17
BIOS Pin Header	17
RTC Switch	17
Mic-in Pin Header	18

Line-out Pin Header.....	18
Line-in Pin Header.....	19
GPIO Pin Header.....	19
FAN Connector.....	20
GPIO Pin Header.....	20
LAN1A LED Pin Header.....	21
LAN1B LED Pin Header.....	21
Reset Pin Header.....	22
PWR_LED/HDD_LED/SMB_BUS/S3/SW_ON/RESET.....	22
3.5G Line-out Pin Header.....	23
3.5G Mic Pin Header.....	23
Power Pin Header.....	24
Reset or On/Off Pin Header.....	24
Flash MCU Code Pin Header.....	25
Locations of the Jumpers and Connectors for the I/O Daughterboard.....	26
Connector Pin Definitions.....	27
External I/O Interfaces - Front Panel.....	27
Remote Power On/Off Switch.....	27
COM1 Port.....	27
COM2 Port.....	28
DC Power Input.....	28
GPIO/Battery LED.....	29
Power/HDD LED.....	29
Internal Connectors.....	30
COM2 RI Pin Header.....	30

Chapter 3: System Setup

Removing the Chassis Cover.....	31
Installing a SO-DIMM.....	33
Installing a Wireless LAN Module (half-size).....	34
Installing a Wireless LAN Module (full-size).....	36
Installing a SIM Card.....	38

Installing a SATA Hard Drive.....	39
Installing a CFast Card.....	41
Installing a Battery.....	42
Packing.....	43

Chapter 4: BIOS Setup

About BIOS Setup.....	45
When to Configure the BIOS.....	45
Default Configuration.....	46
Entering Setup.....	46
Legends.....	46
BIOS Setup Utility.....	48
Main.....	48
Advanced.....	49
Chipset.....	56
Security.....	60
Boot.....	60
Save & Exit.....	61

Appendix A: Power Consumption.....62

Appendix B: GPI/O Programming Guide.....63

Appendix C: Watchdog Timer Setting.....65

Preface

Copyright

This publication, including all photographs, illustrations and software, is protected under international copyright laws, with all rights reserved. No part of this manual may be reproduced, copied, translated or transmitted in any form or by any means without the prior written consent from NEXCOM International Co., Ltd.

Disclaimer

The information in this document is subject to change without prior notice and does not represent commitment from NEXCOM International Co., Ltd. However, users may update their knowledge of any product in use by constantly checking its manual posted on our website: <http://www.nexcom.com>. NEXCOM shall not be liable for direct, indirect, special, incidental, or consequential damages arising out of the use of any product, nor for any infringements upon the rights of third parties, which may result from such use. Any implied warranties of merchantability or fitness for any particular purpose is also disclaimed.

Acknowledgements

NISE 105 is a trademark of NEXCOM International Co., Ltd. All other product names mentioned herein are registered trademarks of their respective owners.

Regulatory Compliance Statements

This section provides the FCC compliance statement for Class B devices and describes how to keep the system CE compliant.

Declaration of Conformity

FCC

This equipment has been tested and verified to comply with the limits for a Class B digital device, pursuant to Part 15 of FCC Rules. These limits are designed to provide reasonable protection against harmful interference when the equipment is operated in a commercial environment. This equipment generates, uses, and can radiate radio frequency energy and, if not installed and used in accordance with the instructions, may cause harmful interference to radio communications. Operation of this equipment in a residential area (domestic environment) is likely to cause harmful interference, in which case the user will be required to correct the interference (take adequate measures) at their own expense.

CE

The product(s) described in this manual complies with all applicable European Union (CE) directives if it has a CE marking. For computer systems to remain CE compliant, only CE-compliant parts may be used. Maintaining CE compliance also requires proper cable and cabling techniques.

RoHS Compliance



NEXCOM RoHS Environmental Policy and Status Update

NEXCOM is a global citizen for building the digital infrastructure. We are committed to providing green products and services, which are compliant with European Union RoHS (Restriction on Use of Hazardous Substance in Electronic Equipment) directive 2011/65/EU, to be your trusted green partner and to protect our environment.

RoHS restricts the use of Lead (Pb) < 0.1% or 1,000ppm, Mercury (Hg) < 0.1% or 1,000ppm, Cadmium (Cd) < 0.01% or 100ppm, Hexavalent Chromium (Cr6+) < 0.1% or 1,000ppm, Polybrominated biphenyls (PBB) < 0.1% or 1,000ppm, and Polybrominated diphenyl Ethers (PBDE) < 0.1% or 1,000ppm.

In order to meet the RoHS compliant directives, NEXCOM has established an engineering and manufacturing task force to implement the introduction of green products. The task force will ensure that we follow the standard NEXCOM development procedure and that all the new RoHS components and new manufacturing processes maintain the highest industry quality levels for which NEXCOM are renowned.

The model selection criteria will be based on market demand. Vendors and suppliers will ensure that all designed components will be RoHS compliant.

How to recognize NEXCOM RoHS Products?

For existing products where there are non-RoHS and RoHS versions, the suffix "(LF)" will be added to the compliant product name.

All new product models launched after January 2013 will be RoHS compliant. They will use the usual NEXCOM naming convention.

Warranty and RMA

NEXCOM Warranty Period

NEXCOM manufactures products that are new or equivalent to new in accordance with industry standard. NEXCOM warrants that products will be free from defect in material and workmanship for 2 years, beginning on the date of invoice by NEXCOM. HCP series products (Blade Server) which are manufactured by NEXCOM are covered by a three year warranty period.

NEXCOM Return Merchandise Authorization (RMA)

- Customers shall enclose the “NEXCOM RMA Service Form” with the returned packages.
- Customers must collect all the information about the problems encountered and note anything abnormal or, print out any on-screen messages, and describe the problems on the “NEXCOM RMA Service Form” for the RMA number apply process.
- Customers can send back the faulty products with or without accessories (manuals, cable, etc.) and any components from the card, such as CPU and RAM. If the components were suspected as part of the problems, please note clearly which components are included. Otherwise, NEXCOM is not responsible for the devices/parts.
- Customers are responsible for the safe packaging of defective products, making sure it is durable enough to be resistant against further damage and deterioration during transportation. In case of damages occurred during transportation, the repair is treated as “Out of Warranty.”
- Any products returned by NEXCOM to other locations besides the customers’ site will bear an extra charge and will be billed to the customer.

Repair Service Charges for Out-of-Warranty Products

NEXCOM will charge for out-of-warranty products in two categories, one is basic diagnostic fee and another is component (product) fee.

Repair Service Charges for Out-of-Warranty Products

NEXCOM will charge for out-of-warranty products in two categories, one is basic diagnostic fee and another is component (product) fee.

System Level

- Component fee: NEXCOM will only charge for main components such as SMD chip, BGA chip, etc. Passive components will be repaired for free, ex: resistor, capacitor.
- Items will be replaced with NEXCOM products if the original one cannot be repaired. Ex: motherboard, power supply, etc.
- Replace with 3rd party products if needed.
- If RMA goods can not be repaired, NEXCOM will return it to the customer without any charge.

Board Level

- Component fee: NEXCOM will only charge for main components, such as SMD chip, BGA chip, etc. Passive components will be repaired for free, ex: resistors, capacitors.
- If RMA goods can not be repaired, NEXCOM will return it to the customer without any charge.

Warnings

Read and adhere to all warnings, cautions, and notices in this guide and the documentation supplied with the chassis, power supply, and accessory modules. If the instructions for the chassis and power supply are inconsistent with these instructions or the instructions for accessory modules, contact the supplier to find out how you can ensure that your computer meets safety and regulatory requirements.

Cautions

Electrostatic discharge (ESD) can damage system components. Do the described procedures only at an ESD workstation. If no such station is available, you can provide some ESD protection by wearing an antistatic wrist strap and attaching it to a metal part of the computer chassis.

Safety Information

Before installing and using the device, note the following precautions:

- Read all instructions carefully.
- Do not place the unit on an unstable surface, cart, or stand.
- Follow all warnings and cautions in this manual.
- When replacing parts, ensure that your service technician uses parts specified by the manufacturer.
- Avoid using the system near water, in direct sunlight, or near a heating device.
- The load of the system unit does not solely rely for support from the rackmounts located on the sides. Firm support from the bottom is highly necessary in order to provide balance stability.
- The computer is provided with a battery-powered real-time clock circuit. There is a danger of explosion if battery is incorrectly replaced. Replace only with the same or equivalent type recommended by the manufacturer. Discard used batteries according to the manufacturer's instructions.
- There must be a disconnect device in front of "NISE 105" to keep the worker or field side maintainer be cautious and aware to close the general power supply before they start to do maintenance. The disconnect device hereby means a 20A circuit-breaker. Power installation must be performed with qualified electrician and followed with National Electrical Code, ANSI/NFPA 70 and Canadian Electrical Code, Part I, CSA C22.1.

- The front of the Equipment requires wiring terminals with the following specifications:

Wire size: 12-24 AWG

Wire Type: copper wire only



Danger of explosion if battery is incorrectly replaced. Replace with the same or equivalent type recommended by the manufacturer. Discard used batteries according to the manufacturer's instructions.

Installation Recommendations

Ensure you have a stable, clean working environment. Dust and dirt can get into components and cause a malfunction. Use containers to keep small components separated.

Adequate lighting and proper tools can prevent you from accidentally damaging the internal components. Most of the procedures that follow require only a few simple tools, including the following:

- A Philips screwdriver
- A flat-tipped screwdriver
- A grounding strap
- An anti-static pad

Using your fingers can disconnect most of the connections. It is recommended that you do not use needle-nose pliers to disconnect connections as these can damage the soft metal or plastic parts of the connectors.

Safety Precautions

1. Read these safety instructions carefully.
2. Keep this User Manual for later reference.
3. Disconnect this equipment from any AC outlet before cleaning. Use a damp cloth. Do not use liquid or spray detergents for cleaning.
4. For plug-in equipment, the power outlet socket must be located near the equipment and must be easily accessible.
5. Keep this equipment away from humidity.
6. Put this equipment on a stable surface during installation. Dropping it or letting it fall may cause damage.
7. The openings on the enclosure are for air convection to protect the equipment from overheating. **DO NOT COVER THE OPENINGS.**
8. Make sure the voltage of the power source is correct before connecting the equipment to the power outlet.
9. Place the power cord in a way so that people will not step on it. Do not place anything on top of the power cord. Use a power cord that has been approved for use with the product and that it matches the voltage and current marked on the product's electrical range label. The voltage and current rating of the cord must be greater than the voltage and current rating marked on the product.
10. All cautions and warnings on the equipment should be noted.
11. If the equipment is not used for a long time, disconnect it from the power source to avoid damage by transient overvoltage.
12. Never pour any liquid into an opening. This may cause fire or electrical shock.
13. Never open the equipment. For safety reasons, the equipment should be opened only by qualified service personnel.
14. If one of the following situations arises, get the equipment checked by service personnel:
 - a. The power cord or plug is damaged.
 - b. Liquid has penetrated into the equipment.
 - c. The equipment has been exposed to moisture.
 - d. The equipment does not work well, or you cannot get it to work according to the user's manual.
 - e. The equipment has been dropped and damaged.
 - f. The equipment has obvious signs of breakage.
15. Do not place heavy objects on the equipment.
16. The unit uses a three-wire ground cable which is equipped with a third pin to ground the unit and prevent electric shock. Do not defeat the purpose of this pin. If your outlet does not support this kind of plug, contact your electrician to replace your obsolete outlet.
17. **CAUTION: DANGER OF EXPLOSION IF BATTERY IS INCORRECTLY REPLACED. REPLACE ONLY WITH THE SAME OR EQUIVALENT TYPE RECOMMENDED BY THE MANUFACTURER. DISCARD USED BATTERIES ACCORDING TO THE MANUFACTURER'S INSTRUCTIONS.**

Technical Support and Assistance

1. For the most updated information of NEXCOM products, visit NEXCOM's website at www.nexcom.com.
2. For technical issues that require contacting our technical support team or sales representative, please have the following information ready before calling:
 - Product name and serial number
 - Detailed information of the peripheral devices
 - Detailed information of the installed software (operating system, version, application software, etc.)
 - A complete description of the problem
 - The exact wordings of the error messages

Warning!

1. Handling the unit: carry the unit with both hands and handle it with care.
2. Maintenance: to keep the unit clean, use only approved cleaning products or clean with a dry cloth.
3. CompactFlash: Turn off the unit's power before inserting or removing a CompactFlash storage card.

Conventions Used in this Manual



Warning:

Information about certain situations, which if not observed, can cause personal injury. This will prevent injury to yourself when performing a task.



Caution:

Information to avoid damaging components or losing data.



Note:

Provides additional information to complete a task easily.



Safety Warning: This equipment is intended for installation in a Restricted Access Location only.

Global Service Contact Information

Headquarters

NEXCOM International Co., Ltd.

15F, No. 920, Chung-Cheng Rd.,
ZhongHe District, New Taipei City, 23586,
Taiwan, R.O.C.

Tel: +886-2-8226-7786

Fax: +886-2-8226-7782

www.nexcom.com

America

USA

NEXCOM USA

2883 Bayview Drive,
Fremont CA 94538, USA

Tel: +1-510-656-2248

Fax: +1-510-656-2158

Email: sales@nexcom.com

www.nexcom.com

Asia

Taiwan

NEXCOM Intelligent Systems

Taipei Office

13F, No.920, Chung-Cheng Rd.,
ZhongHe District,
New Taipei City, 23586, Taiwan, R.O.C.

Tel: +886-2-8226-7796

Fax: +886-2-8226-7792

Email: sales@nexcom.com.tw

www.nexcom.com.tw

NEXCOM Intelligent Systems

Taichung Office

16F, No.250, Sec. 2, Chongde Rd.,
Beitun Dist.,

Taichung City 406, R.O.C.

Tel: +886-4-2249-1179

Fax: +886-4-2249-1172

Email: sales@nexcom.com.tw

www.nexcom.com.tw

Japan

NEXCOM Japan

9F, Tamachi Hara Bldg.,
4-11-5, Shiba Minato-ku,
Tokyo, 108-0014, Japan

Tel: +81-3-5419-7830

Fax: +81-3-5419-7832

Email: sales@nexcom-jp.com

www.nexcom-jp.com

China

NEXCOM China

1F & 2F, Block A, No. 16 Yonyou Software Park,
No. 68 Beiqing Road, Haidian District,
Beijing, 100094, China

Tel: +86-010-5704-2680

Fax: +86-010-5704-2681

Email: sales@nexcom.cn

www.nexcom.cn

Chengdu Office

9F, Shuxiangxie, Xuefu Garden,
No.12 Section 1, South Yihuan Rd.,
Chengdu, 610061, China
Tel: +86-28-8523-0186
Fax: +86-28-8523-0186
Email: sales@nexcom.cn
www.nexcom.cn

Shanghai Office

Room 603/604, Huiyinmingzun Plaza Bldg., 1,
No.609, Yunlin East Rd.,
Shanghai, 200333, China
Tel: +86-21-5278-5868
Fax: +86-21-3251-6358
Email: sales@nexcom.cn
www.nexcom.cn

Shenzhen Office

Room1707, North Block, Pines Bldg.,
No.7 Tairan Rd., Futian Area,
Shenzhen, 518040, China
Tel: +86-755-8332-7203
Fax: +86-755-8332-7213
Email: sales@nexcom.cn
www.nexcom.cn

Wuhan Office

1-C1804/1805, Mingze Liwan, No. 519
South Luoshi Rd., Hongshan District,
Wuhan, 430070, China
Tel: +86-27-8722-7400
Fax: +86-27-8722-7400
Email: sales@nexcom.cn
www.nexcom.cn

Europe

United Kingdom

NEXCOM EUROPE

10 Vincent Avenue,
Crownhill Business Centre,
Milton Keynes, Buckinghamshire
MK8 0AB, United Kingdom
Tel: +44-1908-267121
Fax: +44-1908-262042
Email: sales.uk@nexcom.eu
www.nexcom.eu

Italy

NEXCOM ITALIA S.r.l

Via Gaudenzio Ferrari 29,
21047 Saronno (VA), Italia
Tel: +39 02 9628 0333
Fax: +39 02 9286 9215
Email: nexcomitalia@nexcom.eu
www.nexcomitalia.it

Ordering Information

The following information below provides ordering information for NISE 105.

NISE 105 (P/N: 10J00010501X0)

Intel® Atom™ Processor E3826 Dual Core Fanless System

NISE 105A (P/N: 10J00010500X0)

Intel® Atom™ Processor E3826 Dual Core All in one Fanless System

Chapter 1: Product Introduction

Overview



Key Features

- Onboard Intel® Atom™ processor E3826 dual core, 1.46GHz
- Dual Independent Display from DVI-I and HDMI
- 2x Intel® I120IT LAN ports support WoL, Teaming and PXE
- 2x USB2.0 & 1 x USB3.0
- 4x COM ports (COM1 & COM2 with RS232/422/485, jumper-free setting)
- 1x Optional Interface for optional Wi-Fi/3.5G/Automation modules
- External RTC battery holder for easy replacement
- Support -20 ~ 70 degree C extended operating temperature
- Support 9-30VDC input

Hardware Specifications

CPU Support

- Onboard Intel® Atom™ processor E3826 Dual Core, 1.46GHz
- Support Intel® Atom™ E3800 processor family from Single Core E3815, Dual Core E3825/E3826/E3827 and Quad Core E3845 with different SKUs

Main Memory

- 1x DDR3L SO-DIMM Socket, Support DDR3L 1066/1333 4GB RAM max., un-buffered and non-ECC

Display Option

- Dual Independent Display
 - HDMI and DVI-D
 - HDMI and VGA (via DVI-I to VGA converter)

I/O Interface - Front

- ATX power on/off switch
- 1x Power Status/1x HDD Access/1x Battery Low/1x Programming LEDs
- 1x External CFast socket
- 1x SIM Card holder
- 2x Intel® I210IT GbE LAN Ports, support Wake on LAN, Teaming and PXE
- 1x DVI-I Display Output
- 1x USB3.0 (900mA per each)
- 1x USB2.0 (500mA per each)
- 2x DB9 for COM1 & COM2, both support RS232/422/485 with auto flow control
 - Jumper-free setting on RS232/422/485
 - Support 5V/12V/Ring function by jumper setting, Ring as the default (COM2 Only)
- 1x Remote Power ON/OFF Switch
- 1x 2-pin DC input, support +9 to 30VDC input

I/O Interface - Rear

- 1x USB2.0
- 1x HDMI
- 1x RTC Battery
- 2x DB9 for COM3 & COM4
 - NISE 105: support RS232 only
 - NISE 105A: support RS232/422/485 with auto flow control
- 1x Mic-in & 1 x Line-out
- 2x Antenna Holes for optional Wi-Fi/3.5G antenna
- 1x Optional I/F for optional mini-PCIe Wi-Fi/3.5G/Hilscher Automation module output

I/O Interface - Internal

- 4x GPI and 4 GPO (5V, TTL Type)

Storage Device

- 1x CFast (SATA2.0)
- 1x 2.5" HDD (SATA2.0)
- 1Mb NVRAM (on NISE105A Only)

Expansion Slot

- 1x Mini-PCIe socket for optional Wi-Fi/3.5G/Hilscher automation modules

Power Requirements

- Power input: +9VDC to 30VDC, 6.6a to 2a

Support OS

- Windows 8
- Windows Embedded Standard 8

- Windows 7
- Windows Embedded Standard 7
- Windows Embedded Compact 7
- Linux Kernel version 3.8.0

Dimensions

- 185mm (W) x 131mm (D) x 54mm (H) without wall-mount bracket

Construction

- Aluminum and Metal Chassis with fanless design

Environment

- Operating Temperature:
Ambient with air flow: -20°C to 70°C with industrial grade device
(According to IEC60068-2-1, IEC60068-2-2, IEC60068-2-14)
- Storage Temperature: -30°C to 85°C
- Relative Humidity: 10% to 95% (non-Condensing)
- Shock Protection:
 - HDD: 20G, half sine, 11ms, IEC60068-27
 - CFast: 50G, half sine, 11ms, IEC60068-27
- Vibration Protection w/HDD Condition:
 - Random: 0.5Grms @ 5~500 Hz, IEC60068-2-64
 - Sinusoidal: 0.5Grms @ 5~500 Hz, IEC60068-2-6
- Vibration Protection w/CFast & SSD Condition:
 - Random: 2Grms @ 5~500 Hz, IEC60068-2-64
 - Sinusoidal: 2Grms @ 5~500 Hz, IEC60068-2-6

Certifications

- CE
- FCC Class A
- UL/cUL

Knowing Your NISE 105

Front Panel

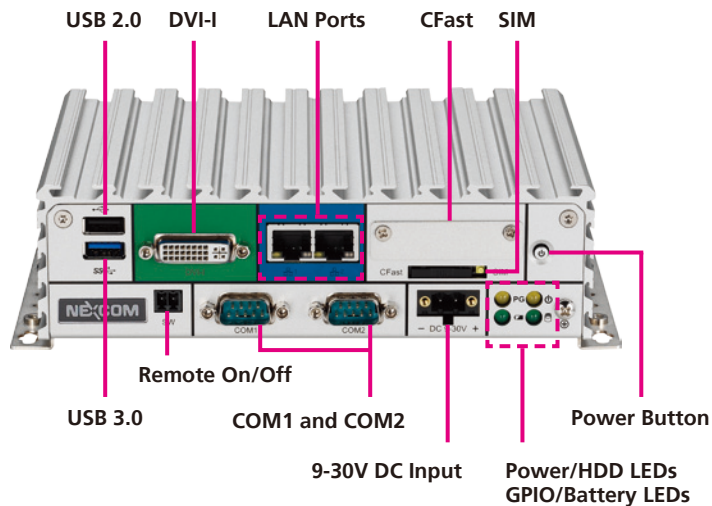

USB 2.0

USB 2.0 port to connect the system with USB 2.0/1.1 devices.

USB 3.0

USB 3.0 port to connect the system with USB 3.0/2.0 devices.

DVI-I

Used to connect a digital LCD panel.

Remote On/Off Switch

Used to connect a remote to power on/off the system.

LAN Ports

Two LAN ports used to connect the system to a local area network.

COM1 and COM2

Two DB9 ports used to connect RS232/422/485 compatible devices.

CFast Slot

Used to insert a CFast card.

SIM Slot

Used to insert a SIM card.

9-30V DC Input

Used to plug a DC power cord.

Power/HDD LEDs

Indicates the power status and HDD activity of the system.

GPIO/Battery LEDs

Indicates the status of the battery and GPIO.

Power Button

Press to power-on or power-off the system.

Rear Panel

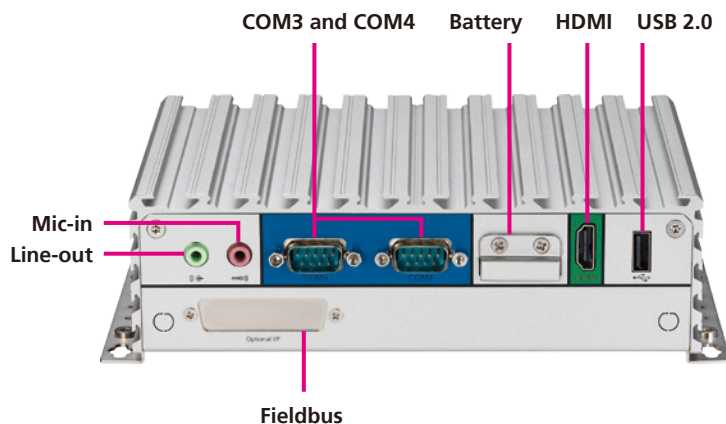

Line-out

Used to connect a headphone or a speaker.

Mic-in

Used to connect an external microphone.

COM3 and COM4

Two DB9 ports used to connect RS232/422/485 compatible devices.

Battery Slot

Used to hold an external battery.

HDMI

Used to connect a high-definition display.

USB 2.0

USB 2.0 port to connect the system with USB 2.0/1.1 devices.

Fieldbus

Expansion slot for add-on fieldbus modules.

Mechanical Dimensions

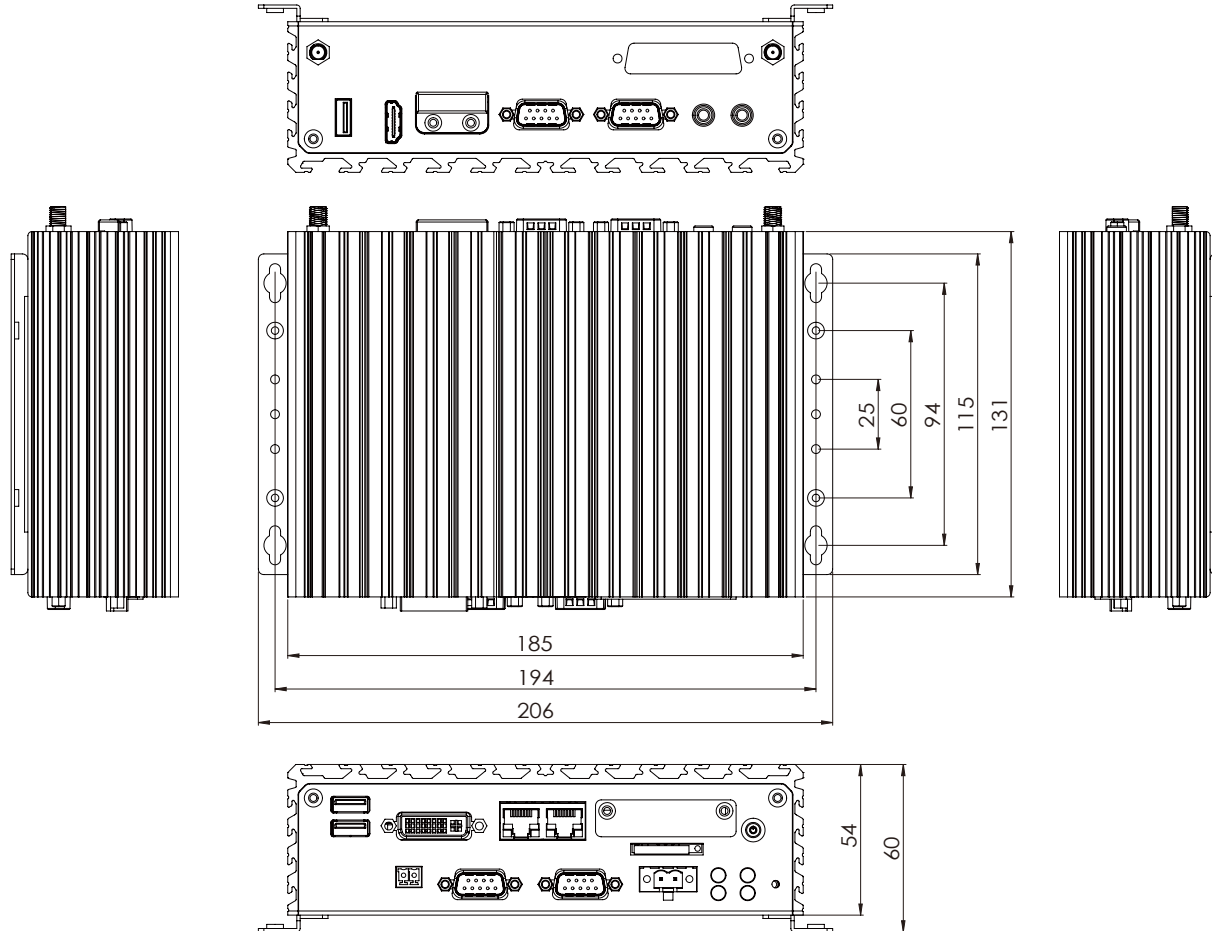

Chapter 2: Jumpers and Connectors

This chapter describes how to set the jumpers and connectors on the NISE 105 motherboard.

Before You Begin

- Ensure you have a stable, clean working environment. Dust and dirt can get into components and cause a malfunction. Use containers to keep small components separated.
- Adequate lighting and proper tools can prevent you from accidentally damaging the internal components. Most of the procedures that follow require only a few simple tools, including the following:
 - A Philips screwdriver
 - A flat-tipped screwdriver
 - A set of jewelers screwdrivers
 - A grounding strap
 - An anti-static pad
- Using your fingers can disconnect most of the connections. It is recommended that you do not use needle-nosed pliers to disconnect connections as these can damage the soft metal or plastic parts of the connectors.
- Before working on internal components, make sure that the power is off. Ground yourself before touching any internal components, by touching a metal object. Static electricity can damage many of the electronic components. Humid environments tend to have less static electricity than

dry environments. A grounding strap is warranted whenever danger of static electricity exists.

Precautions

Computer components and electronic circuit boards can be damaged by discharges of static electricity. Working on computers that are still connected to a power supply can be extremely dangerous.

Follow the guidelines below to avoid damage to your computer or yourself:

- Always disconnect the unit from the power outlet whenever you are working inside the case.
- If possible, wear a grounded wrist strap when you are working inside the computer case. Alternatively, discharge any static electricity by touching the bare metal chassis of the unit case, or the bare metal body of any other grounded appliance.
- Hold electronic circuit boards by the edges only. Do not touch the components on the board unless it is necessary to do so. Don't flex or stress the circuit board.
- Leave all components inside the static-proof packaging that they shipped with until they are ready for installation.
- Use correct screws and do not over tighten screws.

Jumper Settings

A jumper is the simplest kind of electric switch. It consists of two metal pins and a cap. When setting the jumpers, ensure that the jumper caps are placed on the correct pins. When the jumper cap is placed on both pins, the jumper is short. If you remove the jumper cap, or place the jumper cap on just one pin, the jumper is open.

Refer to the illustrations below for examples of what the 2-pin and 3-pin jumpers look like when they are short (on) and open (off).

Two-Pin Jumpers: Open (Left) and Short (Right)

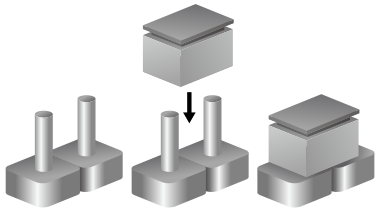

Three-Pin Jumpers: Pins 1 and 2 are Short

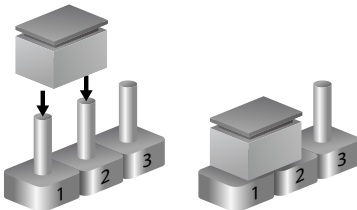

NISE 105 System Components

The NISE 105 system is made up of a NISB 105 motherboard and an I/O daughterboard. This chapter lists the location and pinout assignment of the jumpers and connectors on each component.

Locations of the Jumpers and Connectors for NISB 105

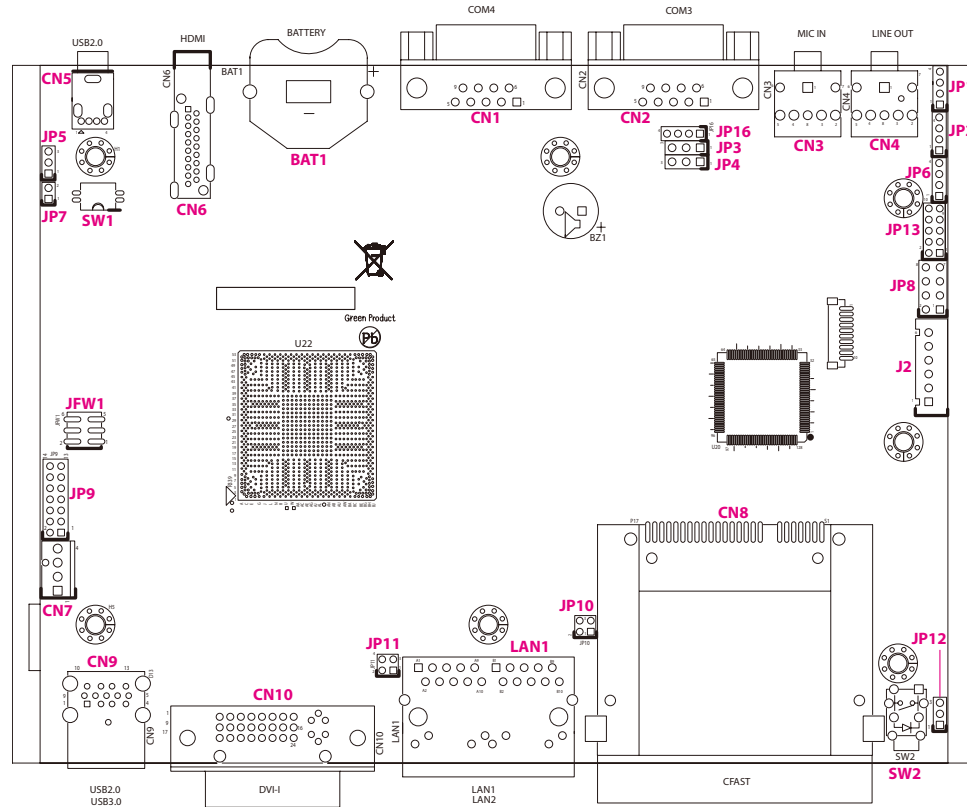

Jumpers

AT/ATX Pin Header

Connector type: 1x3 3-pin header, 2.0mm pitch

Connector location: JP5



Pin	Function
1-2	AT
2-3*	ATX

Connector Pin Definitions

External I/O Interfaces - Front Panel

USB 3.0 and USB 2.0 Port

Connector type: USB 3.0 and USB 2.0 port

Connector location: CN9

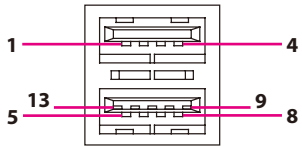

Pin	Definition	Pin	Definition
1	P5V_OC01_C	2	USB_ON_C
3	USB_OP_C	4	GND
5	USB3_RX0_N_C	6	USB3_RX0_P_C
7	GND	8	USB3_TX0_N_C
9	USB3_TX0_P_C	10	P5V_OC01_C
11	USB_1N_C	12	USB_1P_C
13	GND	MH1	F_GND
MH2	F_GND	MH3	F_GND
MH4	F_GND		

DVI-I Connector

Connector type: 24-pin D-Sub, 2.0mm-M-180 (DVI)

Connector location: CN10

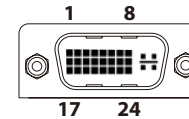

Pin	Definition	Pin	Definition
1	TX2-	2	TX2+
3	GND	4	NC
5	NC	6	DDC_CLK
7	DDC_DATA	8	VSYNC_VGA
9	TX1-	10	TX1+
11	GND	12	NC
13	NC	14	DVI_VCC(+5V)
15	GND	16	HotPlugDet
17	TX0-	18	TX0+
19	GND	20	DDCCLK_VGA
21	DDCDATA_VGA	22	GND
23	TXCLK+	24	TXCLK-
C1	RED	C2	GREEN
C3	BLUE	C4	HSYNC_VGA
C5A	VGADET	C5B	GND
MH1	CHASSIS_GND	MH2	CHASSIS_GND

LAN1 and LAN2 Ports

Connector type: Dual RJ45 port with LEDs

Connector location: LAN1A (LAN1) and LAN1B (LAN2)

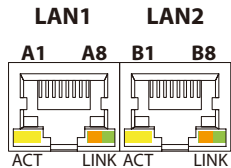

Act	Status
Flashing Yellow	Data activity
Off	No activity

Link	Status
Steady Green	1G network link
Steady Orange	100Mbps network link
Off	No link

LAN1

Pin	Definition	Pin	Definition
A1	LAN1_MDI0P	A2	LAN1_MDI0N
A3	LAN1_MDI1P	A4	LAN1_MDI1N
A5	LAN1_MDI2P	A6	LAN1_MDI2N
A7	LAN1_MDI3P	A8	LAN1_MDI3N
A9	V1P5_LAN	A10	GND
A11	LAN1_LINK100#	A12	LAN1_LINK1G#
A13	LAN1_LED_ACT#	A14	3VSB
MH1	CHASSIS_GND		

LAN2

Pin	Definition	Pin	Definition
B1	LAN2_MDI0P	B2	LAN2_MDI0N
B3	LAN2_MDI1P	B4	LAN2_MDI1N
B5	LAN2_MDI2P	B6	LAN2_MDI2N
B7	LAN2_MDI3P	B8	LAN2_MDI3N
B9	V1P5_LAN2	B10	GND
B11	LAN2_LINK100#	B12	LAN2_LINK1G#
B13	LAN2_LED_ACT#	B14	3VSB
MH2	CHASSIS_GND		

CFast

Connector type: Standard CFast connector

Connector location: CN8

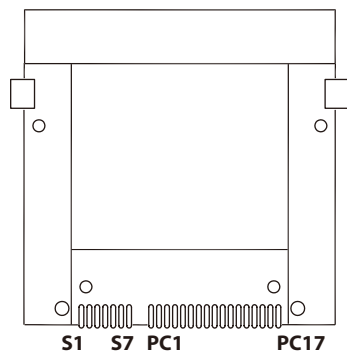

Pin	Definition	Pin	Definition
S1	GND	S2	SATA_TXP1
S3	SATA_TXN1	S4	GND
S5	SATA_RXN1	S6	SATA_RXP1
S7	GND	PC1	CFAST_CDI
PC2	GND	PC3	NC
PC4	NC	PC5	NC
PC6	NC	PC7	GND
PC8	NC	PC9	CFAST_ACCESS
PC10	NC	PC11	NC
PC12	NC	PC13	VCC3
PC14	VCC3	PC15	GND
PC16	GND	PC17	CFAST_CDO
MH1	CHASSIS_GND	MH2	CHASSIS_GND

Power Switch

Connector location: SW2



Pin	Definition	Pin	Definition
1	GND	2	3VSB
3	3VSB	4	GND
A1	PWRLED_N	C1	PWRLED_P
MH1	NC	MH2	NC

External I/O Interfaces - Rear Panel

Audio Connectors

Connector type: 2x 3.5mm TRS

Connector location: CN4 (Line-out) and CN3 (Mic-in)



Line-out Mic-in

Line-out

Pin	Definition	Pin	Definition
1	AGND	2	OUT_R
3	NC	4	NC
5	OUT_L		

Mic-in

Pin	Definition	Pin	Definition
1	MIC_GND	2	MIC1_R3
3	NC	4	NC
5	MIC1_L3		

COM3 Port

Connector type: DB-9 port, 9-pin D-Sub

Connector location: CN2

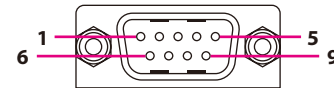

RS232		RS485		RS422	
Pin	Definition	Pin	Definition	Pin	Definition
1	SP3_DCD	1	SP3_DATA-	1	SP3_TX-
2	SP3_RXD	2	SP3_DATA+	2	SP3_TX+
3	SP3_TXD	3	NC	3	SP3_RX+
4	SP3_DTR	4	NC	4	SP3_RX-
5	GND	5	GND	5	GND
6	SP3_DSR	6	NC	6	SP3_RTS-
7	SP3_RTS	7	NC	7	SP3_RTS+
8	SP3_CTS	8	NC	8	SP3_CTS+
9	SP3_RI	9	NC	9	SP3_CTS-

COM4 Port

Connector type: DB-9 port, 9-pin D-Sub
Connector location: CN1

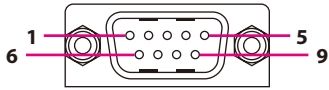

RS232		RS485		RS422	
Pin	Definition	Pin	Definition	Pin	Definition
1	SP4_DCD	1	SP4_DATA-	1	SP4_TX-
2	SP4_RXD	2	SP4_DATA+	2	SP4_TX+
3	SP4_TXD	3	NC	3	SP4_RX+
4	SP4_DTR	4	NC	4	SP4_RX-
5	GND	5	GND	5	GND
6	SP4_DSR	6	NC	6	SP4_RTS-
7	SP4_RTS	7	NC	7	SP4_RTS+
8	SP4_CTS	8	NC	8	SP4_CTS+
9	SP4_RI	9	NC	9	SP4_CTS-

HDMI

Connector type: HDMI port
Connector location: CN6

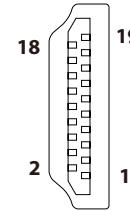

Pin	Definition	Pin	Definition
1	HDMI_DATA2_P	2	GND
3	HDMI_DATA2_N	4	HDMI_DATA1_P
5	GND	6	HDMI_DATA1_N
7	HDMI_DATA0_P	8	GND
9	HDMI_DATA0_N	10	HDMI_CLK_P
11	GND	12	HDMI_CLK_N
13	NC	14	NC
15	HDMI_CTRL_CLK	16	HDMI_CTRL_DATA
17	GND	18	VCC5_HDMI
19	HDMI_HPD_R	MH1	CHASSIS_GND
MH2	CHASSIS_GND	MH3	CHASSIS_GND
MH4	CHASSIS_GND		

USB 2.0 Port

Connector type: DB-9 port, 9-pin D-Sub

Connector location: CN5

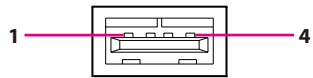

Pin	Definition	Pin	Definition
1	P5V_OC2_C	2	USB_2N_C
3	USB_2P_C	4	GND
MH1	CHASSIS_GND	MH2	CHASSIS_GND
MH3	CHASSIS_GND		

Internal Connectors

BIOS Pin Header

Connector type: 2x3 6-pin header, 2.0mm

Connector location: JFW1

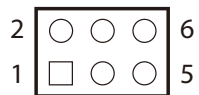

Pin	Definition	Pin	Definition
1	VCC	2	GND
3	CS#0	4	CLK
5	SO	6	SI

RTC Switch

Connector location: SW1

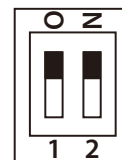

Pin	Definition
1	RTC
2	3VSB
3	RTC_TEST#
4	SRTC_TEST#

Mic-in Pin Header

Connector type: 1x4 4-pin header, 2.0mm pitch

Connector location: JP2



Pin	Definition
1	MIC1_L3
2	NC
3	MIC_GND
4	MIC1_R3

Line-out Pin Header

Connector type: 1x4 4-pin header, 2.0mm pitch

Connector location: JP1



Pin	Definition
1	OUT_L
2	NC
3	AGND
4	OUT_R

Line-in Pin Header

Connector type: 1x4 4-pin header, 2.0mm pitch

Connector location: JP6



Pin	Definition
1	FLIN_L
2	LIN_JD
3	LIN_GND
4	FLIN_R

GPIO Pin Header

Connector type: 2x4 8-pin header, 2.54mm pitch

Connector location: JP8

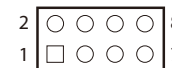

Pin	Definition	Pin	Definition
1	VCC5	2	VCC5
3	KDAT_R	4	MDAT_R
5	KCLK_R	6	MCLK_R
7	GND	8	GND

FAN Connector

Connector type: 1x4 4-pin Wafer, 2.54mm pitch

Connector location: CN7



Pin	Definition
1	GND
2	VCC12
3	CPUFANIN
4	CPUFANOUT

GPIO Pin Header

Connector type: 2x5 10-pin header, 2.00mm pitch

Connector location: JP13

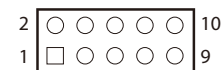

Pin	Definition	Pin	Definition
1	VCC5	2	GND
3	ICH_GPO0_OUT	4	ICH_GPIO_IN
5	ICH_GPO1_OUT	6	ICH_GPI1_IN
7	ICH_GPO2_OUT	8	ICH_GPI2_IN
9	ICH_GPO3_OUT	10	ICH_GPI3_IN

LAN1A LED Pin Header

Connector type: 2x2 4-pin header, 2.00mm pitch

Connector location: JP11

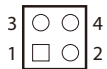

Pin	Definition
1	LAN1_ACT_CON
2	LAN1_LED_ACT#
3	LAN1_LINK1G#
4	LAN1_100#_CON

LAN1B LED Pin Header

Connector type: 2x2 4-pin header, 2.00mm pitch

Connector location: JP10

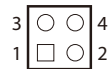

Pin	Definition
1	LAN2_ACT_CON
2	LAN2_LED_ACT#
3	LAN2_LINK1G#
4	LAN2_100#_CON

Reset Pin Header

Connector type: 1x2 2-pin header, 2.0mm pitch

Connector location: JP7



Pin	Definition
1	PM_RESET#_J
2	GND

PWR_LED/HDD_LED/SMB_BUS/S3/SW_ON/RESET

Connector type: 2x7 14-pin header, 2.0mm pitch

Connector location: JP9

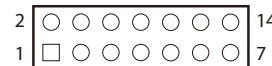

Pin	Definition	Pin	Definition
1	PWR_LED_N	2	POWER_LED_PWR
3	HDD_LED_N	4	HDD_LED_PWR
5	SMB_CLK	6	SMB_DATA
7	3VSB	8	GND
9	SLP_S3#	10	PSON
11	PBT_SW	12	GND
13	PM_RESET#_J	14	GND

3.5G Line-out Pin Header

Connector type: 1x3 3-pin header, 2.54mm pitch
Connector location: JP3



Pin	Definition
1	LOUT_RL
2	LOUT_RR
3	ANGND

3.5G Mic Pin Header

Connector type: 1x3 3-pin header, 2.54mm pitch
Connector location: JP4



Pin	Definition
1	MIC_RL
2	MIC_RR
3	ANGND

Power Pin Header

Connector type: 1x6 JST, 6-pin header, 2.5mm pitch

Connector location: J2

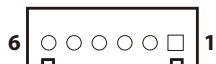

Pin	Definition	Pin	Definition
1	12VSB	2	12VSB
3	12VSB	4	GND
5	GND	6	POWER_STATUS

Reset or On/Off Pin Header

Connector type: 1x3 3-pin header, 2.0mm pitch

Connector location: JP12



Pin	Definition
1	PBT_TR
2	PBT_SW
3	PM_RESET#_J

Flash MCU Code Pin Header

Connector type: 1x4 4-pin header, 2.0mm pitch

Connector location: JP16



Pin	Definition
1	3VSB
2	SBW_TCK
3	SBW_TDIO
4	GND

Locations of the Jumpers and Connectors for the I/O Daughterboard

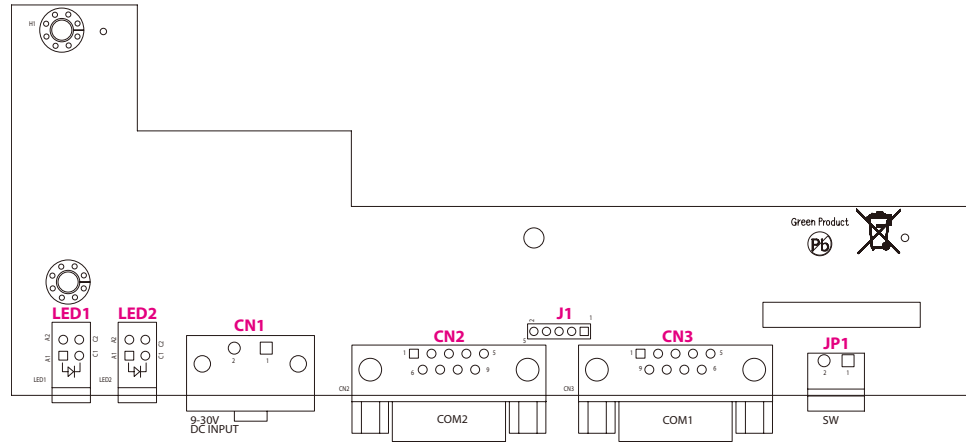

Connector Pin Definitions

External I/O Interfaces - Front Panel

Remote Power On/Off Switch

Connector type: 2-pin switch

Connector location: JP1

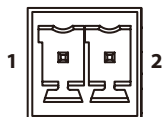

Pin	Definition
1	PBT_PU
2	GND

COM1 Port

Connector type: DB-9 port, 9-pin D-Sub

Connector location: CN3

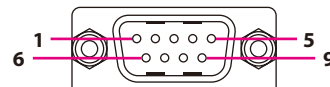

RS232		RS485		RS422	
Pin	Definition	Pin	Definition	Pin	Definition
1	SP1_DCD	1	SP1_DATA-	1	SP1_TX-
2	SP1_RXD	2	SP1_DATA+	2	SP1_TX+
3	SP1_TXD	3	NC	3	SP1_RX+
4	SP1_DTR	4	NC	4	SP1_RX-
5	GND	5	GND	5	GND
6	SP1_DSR	6	NC	6	SP1_RTS-
7	SP1_RTS	7	NC	7	SP1_RTS+
8	SP1_CTS	8	NC	8	SP1_CTS+
9	SP1_RI	9	NC	9	SP1_CTS-

COM2 Port

Connector type: DB-9 port, 9-pin D-Sub

Connector location: CN2

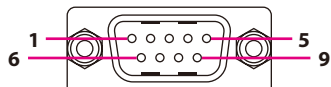

RS232		RS485		RS422	
Pin	Definition	Pin	Definition	Pin	Definition
1	SP1_DCD	1	SP1_DATA-	1	SP1_TX-
2	SP1_RXD	2	SP1_DATA+	2	SP1_TX+
3	SP1_TXD	3	NC	3	SP1_RX+
4	SP1_DTR	4	NC	4	SP1_RX-
5	GND	5	GND	5	GND
6	SP1_DSR	6	NC	6	SP1_RTS-
7	SP1_RTS	7	NC	7	SP1_RTS+
8	SP1_CTS	8	NC	8	SP1_CTS+
9	SP1_RI	9	NC	9	SP1_CTS-

DC Power Input

Connector type: 2-pin terminal block

Connector location: CN1



Pin	Definition
1	GND_FLT
2	VIN

GPIO/Battery LED

Connector location: LED2



Pin	Definition
A1	VCC5
A2	BAT_LED
C1	GPIO_LED_N
C2	GND

Power/HDD LED

Connector location: LED1



Pin	Definition
A1	VCC5
A2	VCC5
C1	PWR_LED_N
C2	HDD_LED_N

Internal Connectors

COM2 RI Pin Header

Connector type: 1x5 5-pin header, 2.0mm

Connector location: J1



Pin	Definition
1-2	VCC5
2-3	VCC12
4-5*	RING

Chapter 3: System Setup

Removing the Chassis Cover



Prior to removing the chassis cover, make sure the unit's power is off and disconnected from the power sources to prevent electric shock or system damage.

1. Locate the 6 screws on the bottom side of the chassis cover.

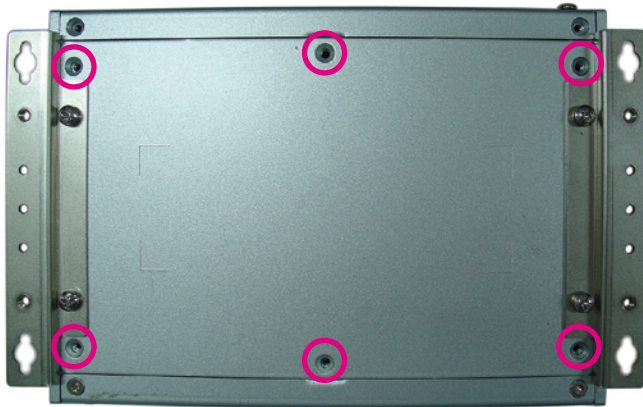

2. Remove the 6 screws on the bottom side of the chassis cover.

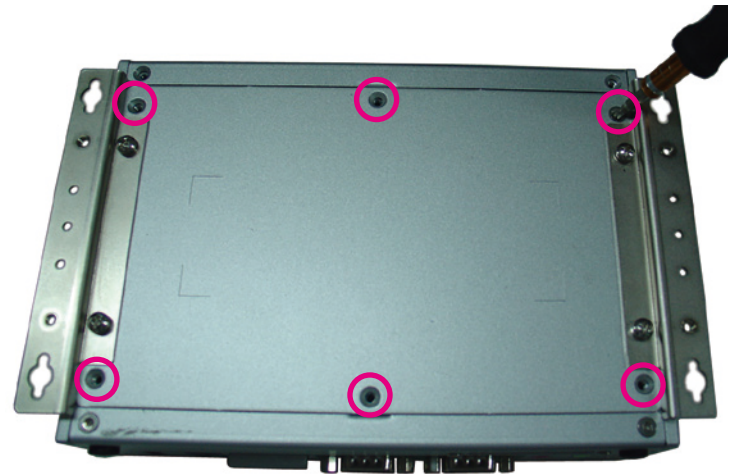

3. Remove the chassis cover.



Installing a SO-DIMM

1. Remove the bottom cover before installing a SO-DIMM.



2. Locate the SO-DIMM socket.

3. Insert the module into the socket at an approximately 30 degree angle. The ejector tabs at the ends of the socket will automatically snap into the locked position to hold the module in place.



Installing a Wireless LAN Module (half-size)

1. Locate the mini-PCIe slot on the board.

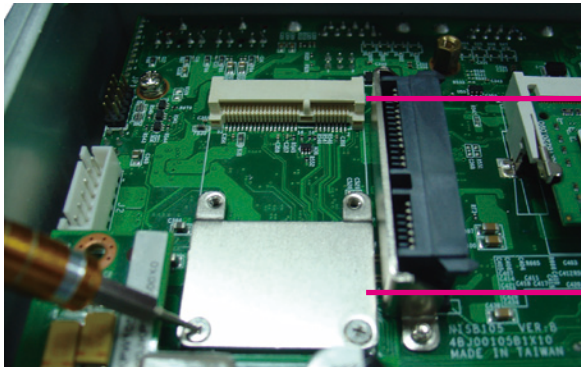

Mini-PCIe slot

Mini-PCIe bracket

2. Remove the mini-PCIe bracket from the board.

3. Install the mini-PCIe bracket to the mini-PCIe module.

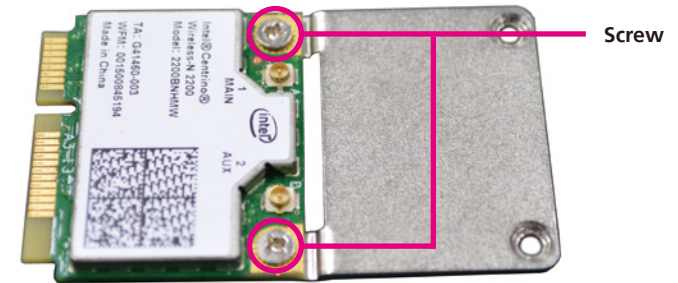

Screw

4. Insert the mini-PCIe module into the mini-PCIe slot at 45 degree angle until the gold-plated connector on the edge of the module completely disappears into the slot.



5. Push the module down and secure it with the screws.



Installing a Wireless LAN Module (full-size)

1. Locate the mini-PCIe slot on the board.

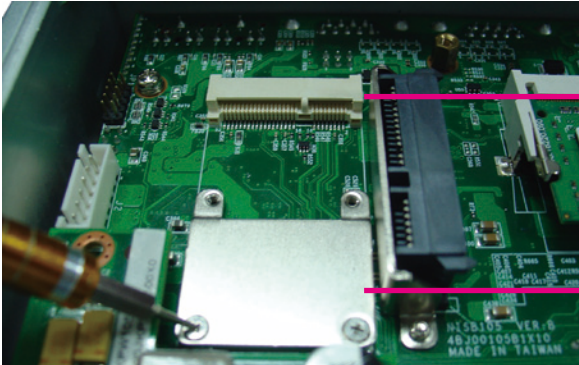

Mini-PCIe slot

Mini-PCIe bracket

2. Remove the mini-PCIe bracket from the board.

3. Insert the mini-PCIe module into the mini-PCIe slot at 45 degree angle until the gold-plated connector on the edge of the module completely disappears into the slot.



4. Push the module down and secure it with the screws.



Installing a SIM Card

1. Locate the SIM card holder and release the cover.



SIM card holder

2. Place the SIM card onto the holder.



3. Close the cover and secure the holder to the original position.



Installing a SATA Hard Drive

1. Remove the bottom cover before installing a SATA HDD.
2. Locate the internal HDD bracket and remove all the 3 screws on the HDD bracket.

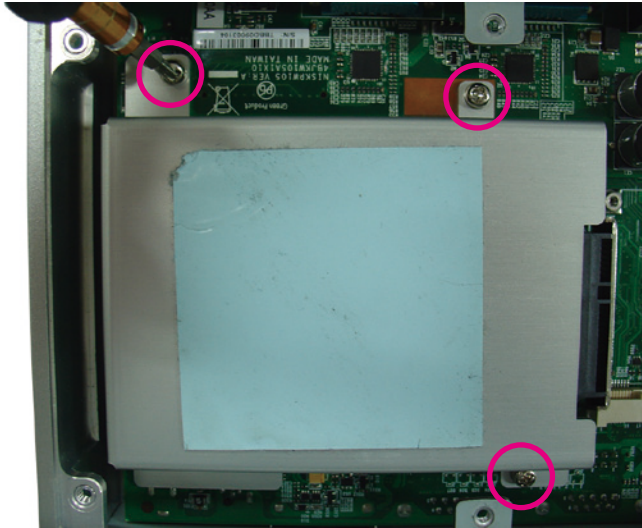

3. Place the 2.5" HDD into the internal HDD bracket then use the screws to secure the 2.5" HDD in place.

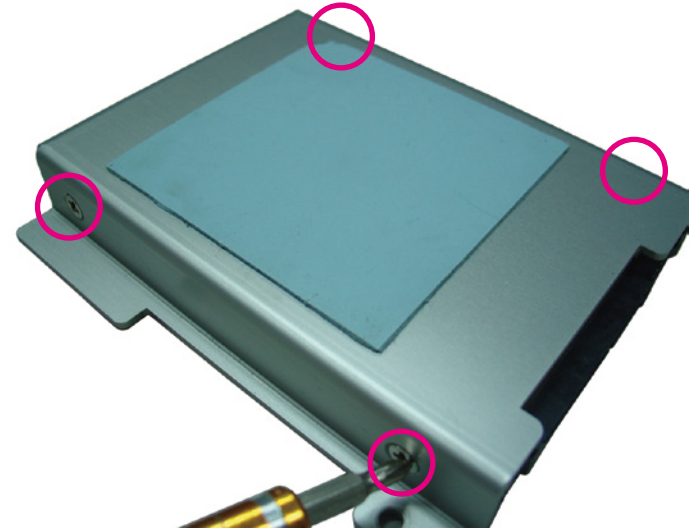

4. Place the internal HDD bracket into its original position.



5. Secure the internal HDD bracket by screwing the screws in a clockwise direction.

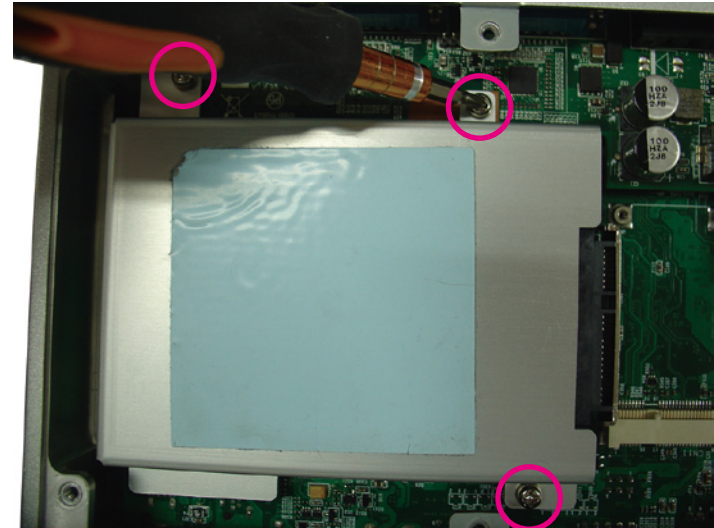

Installing a CFast Card

1. Locate the CFast slot at the front and remove the cover on the slot.



2. Insert the CFast card into the slot and fasten the cover.



Installing a Battery

1. Locate the battery slot at the front and remove the cover on the slot.

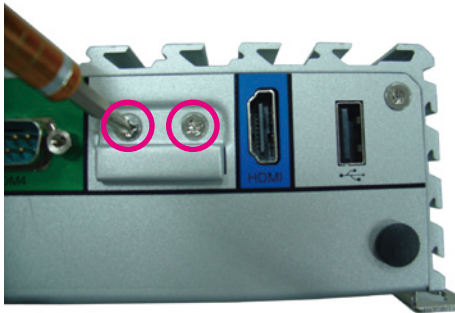

2. Insert the battery into the slot and fasten the cover.



Packing



NISE 105 plastic bag and EPE reference.

Front View of Packing

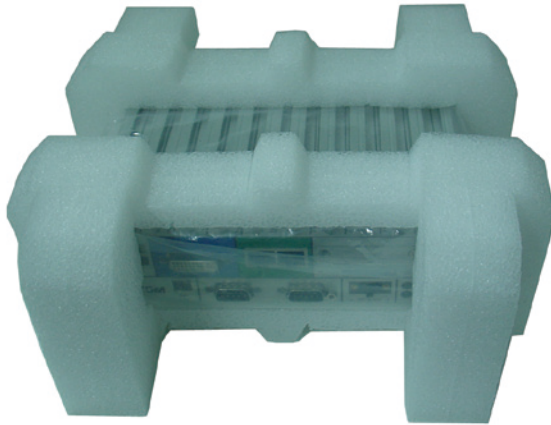

Rear View of Packing



Top View of Packing

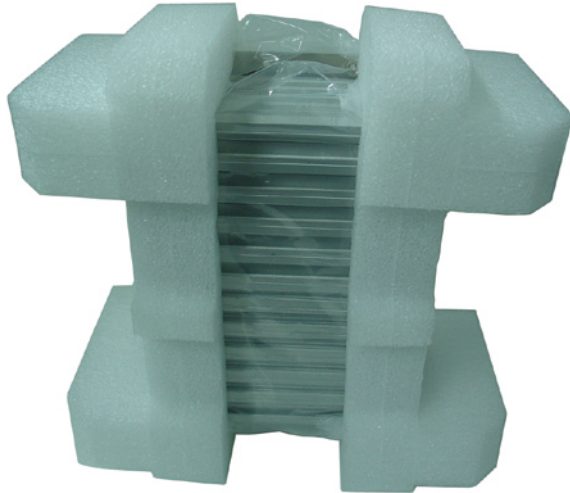

Bottom View of Packing



Chapter 4: BIOS Setup

This chapter describes how to use the BIOS setup program for the NISE 105. The BIOS screens provided in this chapter are for reference only and may change if the BIOS is updated in the future.

To check for the latest updates and revisions, visit the NEXCOM Web site at www.nexcom.com.tw.

About BIOS Setup

The BIOS (Basic Input and Output System) Setup program is a menu driven utility that enables you to make changes to the system configuration and tailor your system to suit your individual work needs. It is a ROM-based configuration utility that displays the system's configuration status and provides you with a tool to set system parameters.

These parameters are stored in non-volatile battery-backed-up CMOS RAM that saves this information even when the power is turned off. When the system is turned back on, the system is configured with the values found in CMOS.

With easy-to-use pull down menus, you can configure such items as:

- Hard drives, diskette drives, and peripherals
- Video display type and display options
- Password protection from unauthorized use
- Power management features

The settings made in the setup program affect how the computer performs. It is important, therefore, first to try to understand all the setup options, and second, to make settings appropriate for the way you use the computer.

When to Configure the BIOS

- This program should be executed under the following conditions:
- When changing the system configuration
- When a configuration error is detected by the system and you are prompted to make changes to the setup program
- When resetting the system clock
- When redefining the communication ports to prevent any conflicts
- When making changes to the Power Management configuration
- When changing the password or making other changes to the security setup

Normally, CMOS setup is needed when the system hardware is not consistent with the information contained in the CMOS RAM, whenever the CMOS RAM has lost power, or the system features need to be changed.

Default Configuration

Most of the configuration settings are either predefined according to the Load Optimal Defaults settings which are stored in the BIOS or are automatically detected and configured without requiring any actions. There are a few settings that you may need to change depending on your system configuration.

Entering Setup

When the system is powered on, the BIOS will enter the Power-On Self Test (POST) routines. These routines perform various diagnostic checks; if an error is encountered, the error will be reported in one of two different ways:

- If the error occurs before the display device is initialized, a series of beeps will be transmitted.
- If the error occurs after the display device is initialized, the screen will display the error message.

Powering on the computer and immediately pressing allows you to enter Setup. Another way to enter Setup is to power on the computer and wait for the following message during the POST:

TO ENTER SETUP BEFORE BOOT PRESS + +

Press the key to enter Setup:

Legends

Key	Function
	Moves the highlight left or right to select a menu.
	Moves the highlight up or down between sub-menus or fields.
	Exits the BIOS Setup Utility.
	Scrolls forward through the values or options of the highlighted field.
	Scrolls backward through the values or options of the highlighted field.
	Selects a field.
	Displays General Help.
	Load previous values.
	Load optimized default values.
	Saves and exits the Setup program.
	Press <Enter> to enter the highlighted sub-menu

Scroll Bar

When a scroll bar appears to the right of the setup screen, it indicates that there are more available fields not shown on the screen. Use the up and down arrow keys to scroll through all the available fields.

Submenu

When “▶” appears on the left of a particular field, it indicates that a submenu which contains additional options are available for that field. To display the submenu, move the highlight to that field and press  .

BIOS Setup Utility

Once you enter the AMI BIOS Setup Utility, the Main Menu will appear on the screen. The main menu allows you to select from several setup functions and one exit. Use arrow keys to select among the items and press  to accept or enter the submenu.

Main

The Main menu is the first screen that you will see when you enter the BIOS Setup Utility.

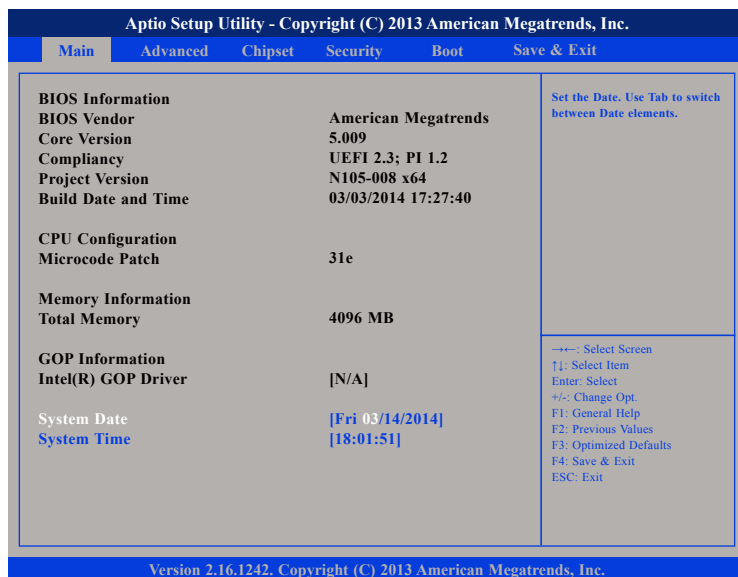

System Date

The date format is <day>, <month>, <date>, <year>. Day displays a day, from Monday to Sunday. Month displays the month, from January to December. Date displays the date, from 1 to 31. Year displays the year, from 1999 to 2099.

System Time

The time format is <hour>, <minute>, <second>. The time is based on the 24-hour military-time clock. For example, 1 p.m. is 13:00:00. Hour displays hours from 00 to 23. Minute displays minutes from 00 to 59. Second displays seconds from 00 to 59.

Advanced

The Advanced menu allows you to configure your system for basic operation. Some entries are defaults required by the system board, while others, if enabled, will improve the performance of your system or let you set some features according to your preference.



Setting incorrect field values may cause the system to malfunction.

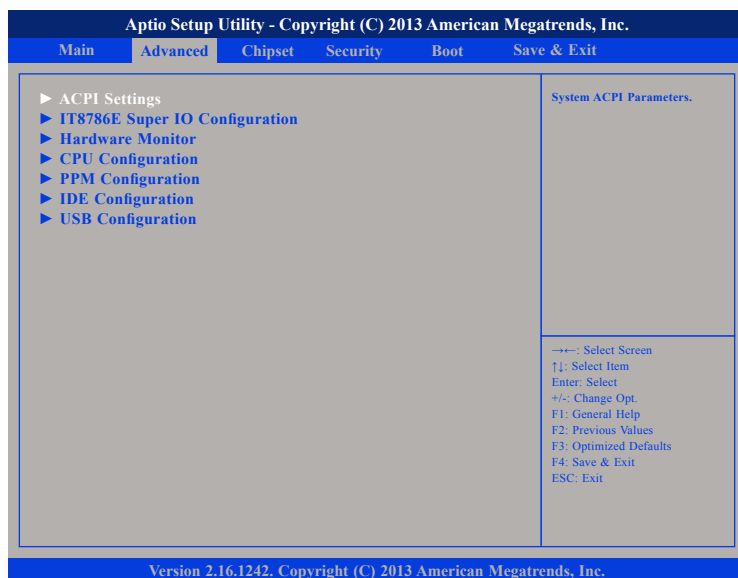

ACPI Settings

This section is used to configure ACPI Settings.

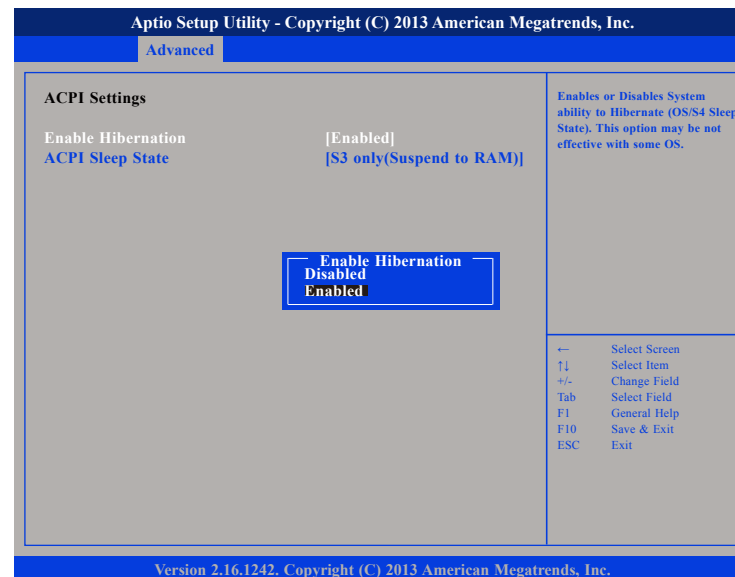

Enable Hibernation

Enables or disables system ability to hibernate (OS/S4 Sleep State). This option may not be effective with some OS.

ACPI Sleep State

Select the highest ACPI sleep state the system will enter when the suspend button is pressed. The options are Suspend Disabled and S3 (Suspend to RAM).

IT8786E Super IO Configuration

This section is used to configure the serial ports.



Super IO Chip

Displays the Super I/O chip used on the board.

Serial Port 1 Configuration

This section is used to configure serial port 1.



Serial Port

Enables or disables the serial port.

Onboard Serial Port Mode

Select this to change the serial port mode to RS232, RS422, RS485 or RS485 Auto.

Serial Port 2 Configuration

This section is used to configure serial port 2.



Serial Port

Enables or disables the serial port.

Onboard Serial Port Mode

Select this to change the serial port mode to RS232, RS422, RS485 or RS485 Auto.

Serial Port 3 Configuration

This section is used to configure serial port 3.

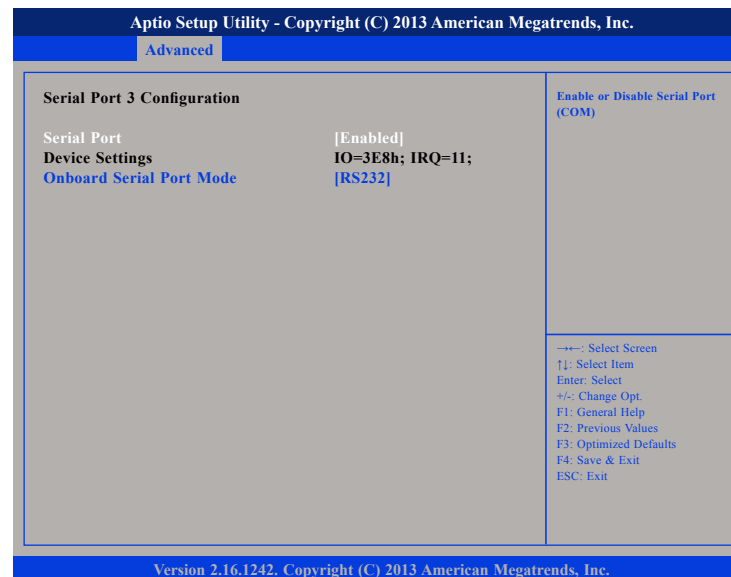

Serial Port

Enables or disables the serial port.

Onboard Serial Port Mode

Select this to change the serial port mode to RS232, RS422, RS485 or RS485 Auto.

Serial Port 4 Configuration

This section is used to configure serial port 4.

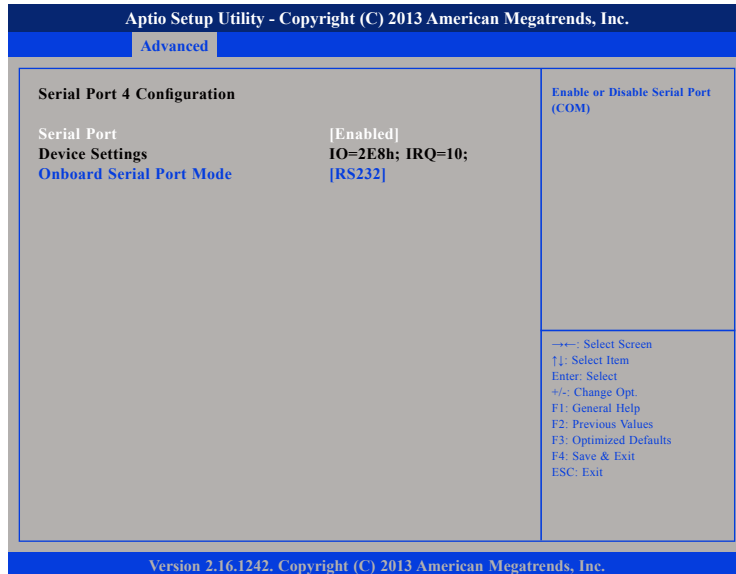

Serial Port

Enables or disables the serial port.

Onboard Serial Port Mode

Select this to change the serial port mode to RS232, RS422, RS485 or RS485 Auto.

PPM Configuration

This section is used to configure the Processor Power Management (PPM) configuration.



EIST

Enables or disables Intel® SpeedStep.

H/W Monitor

This section is used to monitor hardware status such as temperature, fan speed and voltages.

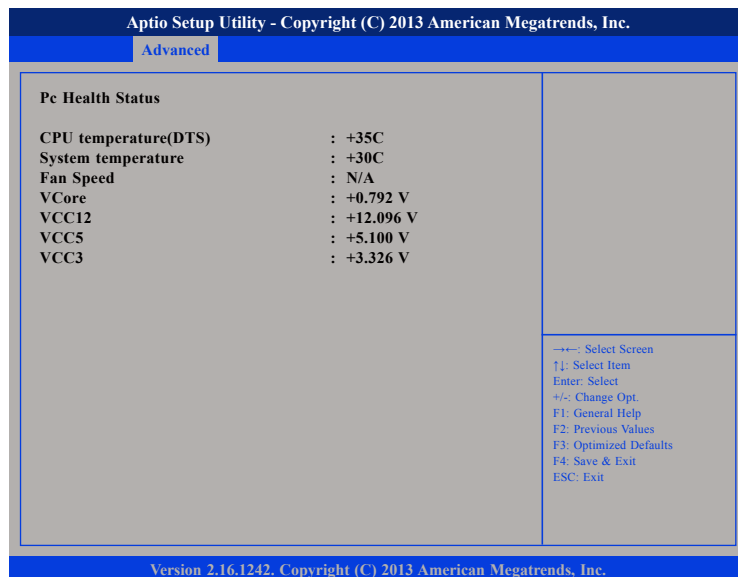

VCore

Detects and displays the Vcore CPU voltage.

VCC12

Detects and displays 12V voltage.

VCC5

Detects and displays 5V voltage.

VCC3

Detects and displays 3.3V voltage.

CPU Temperature

Detects and displays the current CPU temperature.

System Temperature

Detects and displays the current system temperature.

Fan Speed

Detects and displays the fan speed.

CPU Configuration

This section is used to configure the CPU.



Active Processor Cores

Select the number of cores to enable in each processor package.

Limit CPUID Maximum

The CPUID instruction of some newer CPUs will return a value greater than 3. The default is Disabled because this problem does not exist in the Windows series operating systems. If you are using an operating system other than Windows, this problem may occur. To avoid this problem, enable this field to limit the return value to 3 or lesser than 3.

Execute Disable Bit

When this field is set to Disabled, it will force the XD feature flag to always return to 0. XD can prevent certain classes of malicious buffer overflow attacks when combined with a supporting OS (Windows Server 2003 SP1, Windows XP SP2, SuSE Linux 9.2, RedHat Enterprise 3 Update 3).

Intel® Virtualization Technology

Enables or disables Intel® Virtualization technology.

Socket 0 CPU Information

This section displays the information of the CPU installed in Socket 0.

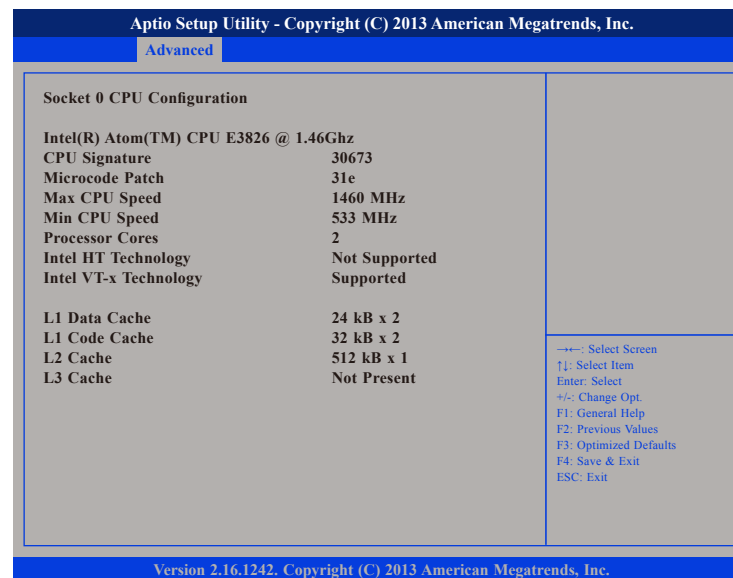

IDE Configuration

This section is used to configure the SATA drives.



Serial-ATA (SATA)

Enables or disables SATA device.

SATA Speed Support

Configures the SATA controller to Gen1 or Gen2 speed.

SATA Mode

Configures the SATA as IDE, AHCI or RAID mode.

SATA Mode

Configures the SATA as IDE, AHCI or RAID mode.

- IDE This option configures the Serial ATA drives as Parallel ATA physical storage device.
- AHCI This option configures the Serial ATA drives to use AHCI (Advanced Host Controller Interface). AHCI allows the storage driver to enable the advanced Serial ATA features which will increase storage performance.

Serial-ATA Port 0 and Serial-ATA Port 1

Enables or disables SATA port 0 and SATA port 1.

SATA Port1 Hotplug and SATA Port2 Hotplug

Enables or disables hotplug support on SATA port 1 and SATA port 2.

USB Configuration

This section is used to configure the USB.



Legacy USB Support

Enable Enables Legacy USB.

Auto Disables support for Legacy when no USB devices are connected.

Disable Keeps USB devices available only for EFI applications.

USB3.0 Support

Enables or disables USB 3.0 controller support.

XHCI Hand-off and EHCI Hand-off

This is a workaround for OSs that does not support XHCI hand-off and EHCI Hand-off. The XHCI and EHCI ownership change should be claimed by the XHCI and EHCI driver respectively.

Chipset

This section gives you functions to configure the system based on the specific features of the chipset. The chipset manages bus speeds and access to system memory resources.



South Bridge

This section is used to configure the south bridge features.

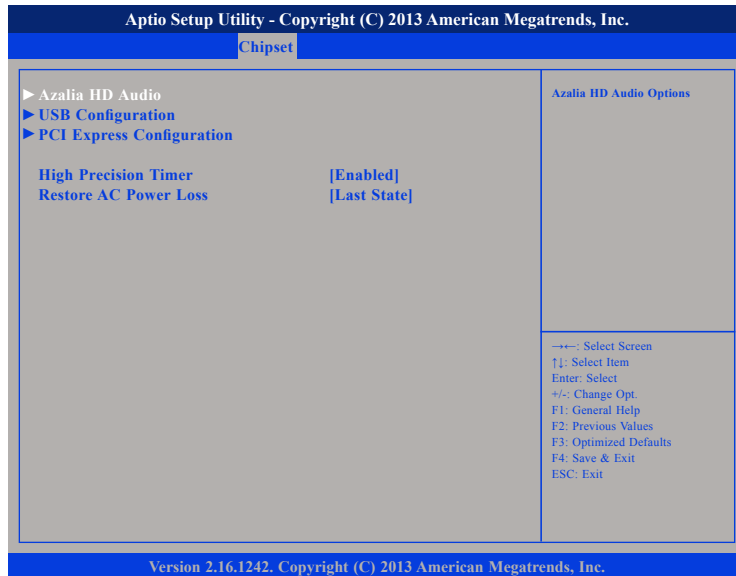

High Precision Timer

Enables or disables the high precision event timer.

Restore AC Power Loss

- Power Off** When power returns after an AC power failure, the system's power is off. You must press the power button to power-on the system.
- Power On** When power returns after an AC power failure, the system will automatically power-on.
- Last State** When power returns after an AC power failure, the system will return to the state where you left off before power failure occurs. If the system's power is off when AC power failure occurs, it will remain off when power returns. If the system's power is on when AC power failure occurs, the system will power-on when power returns.

PCH Azalia Configuration

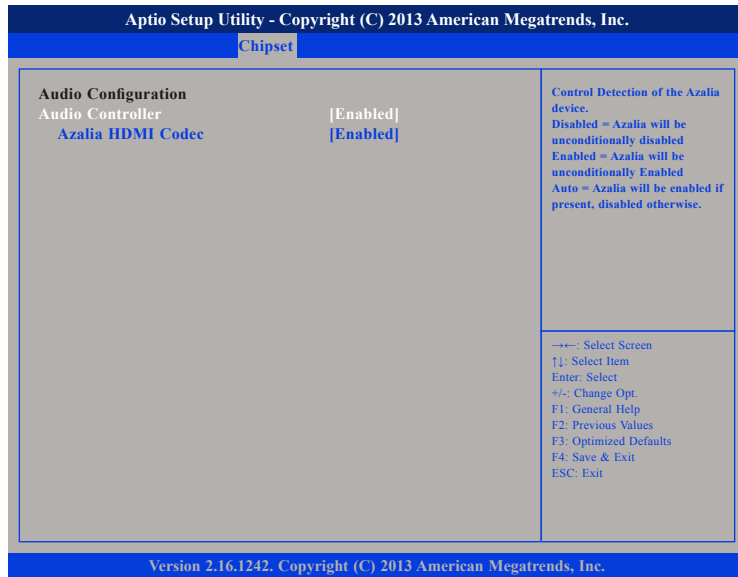

Azalia

Control detection of the Azalia device.

- Disabled Azalia will be unconditionally disabled.
- Enabled Azalia will be unconditionally Enabled.

Azalia HDMI Codec

Enables or disables internal HDMI codec for Azalia.

USB Configuration

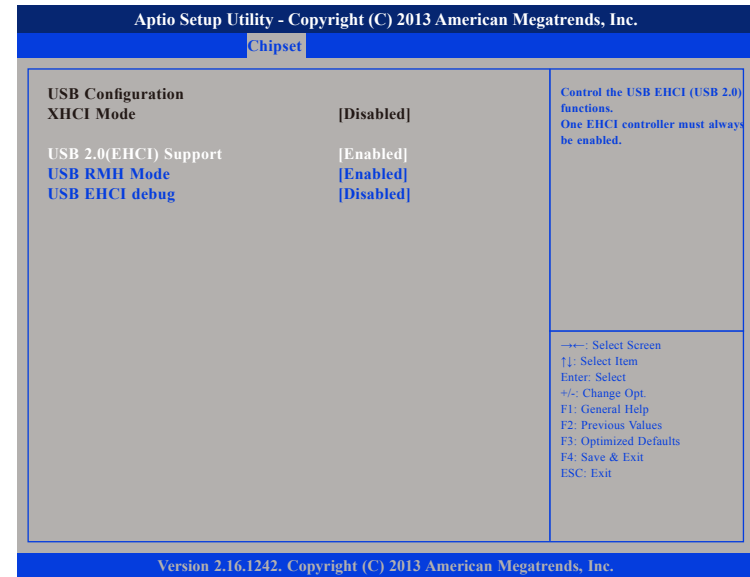

USB 2.0(EHCI) Support

Enables or disables the Enhanced Host Controller Interface (USB 2.0), one EHCI controller must always be enabled.

USB RMH Mode

Enables or disables PCH USB rate matching hubs mode.

USB EHCI Debug

Enables or disables PCH EHCI debug capability.

PCI Express Configuration



PCI Express Port 0 to PCI Express Port 2

Enables or disables the PCI Express ports 0 to 2 on the chipset.

Security

Aptio Setup Utility - Copyright (C) 2013 American Megatrends, Inc.					
Main	Advanced	Chipset	Security	Boot	Save & Exit
<p>Password Description</p> <p>If ONLY the Administrator's password is set, then this only limits access to Setup and is only asked for when entering Setup. If ONLY the User's password is set, then this is a power on password and must be entered to boot or enter Setup. In Setup the User Will have Administrator rights. The password length must be in the following range:</p> <p>Minimum length 3 Maximum 20</p> <p>Administrator Password User Password</p>		<p>Set Administrator Password</p> <p>←→: Select Screen ↑↓: Select Item Enter: Select +/-: Change Opt. F1: General Help F2: Previous Values F3: Optimized Defaults F4: Save & Exit ESC: Exit</p>			
Version 2.16.1242. Copyright (C) 2013 American Megatrends, Inc.					

Administrator Password

Select this to reconfigure the administrator's password.

User Password

Select this to reconfigure the user's password.

Boot

This section is used to configure the boot features.

Aptio Setup Utility - Copyright (C) 2013 American Megatrends, Inc.					
Main	Advanced	Chipset	Security	Boot	Save & Exit
<p>Boot Configuration</p> <p>Bootup NumLock State [On] Fast Boot [Disabled]</p> <p>Network [Disabled] Video [Legacy only]</p> <p>Boot Option Priorities</p> <p>Boot Option #1 [P0: ST320LT012-9WS1 . . .] Boot Option #2 [UEFI: Built-in EFI . . .]</p> <p>Hard Drive BBS Priorities</p>		<p>Select the keyboard NumLock state</p> <p>←→: Select Screen ↑↓: Select Item Enter: Select +/-: Change Opt. F1: General Help F2: Previous Values F3: Optimized Defaults F4: Save & Exit ESC: Exit</p>			
Version 2.16.1242. Copyright (C) 2013 American Megatrends, Inc.					

Bootup NumLock State

This allows you to determine the default state of the numeric keypad. By default, the system boots up with NumLock on wherein the function of the numeric keypad is the number keys. When set to Off, the function of the numeric keypad is the arrow keys.

Fast Boot

When enabled, the BIOS will shorten or skip some check items during POST. This will decrease the time needed to boot the system.

Network

Controls the execution of UEFI and legacy PXE OpROM.

Video

Controls the execution of UEFI and legacy video OpROM.

Boot Option Priorities

Adjust the boot sequence of the system. Boot Option #1 is the first boot device that the system will boot from, next will be #2 and so forth.

Hard Drive BBS Priorities

Boot Option #1



Sets the system boot order.

Save & Exit



Save Changes and Reset

To save the changes and reset, select this field then press <Enter>. A dialog box will appear. Confirm by selecting Yes.

Discard Changes and Reset

To exit the Setup utility without saving the changes, select this field then press <Enter>. You may be prompted to confirm again before exiting.

Restore Defaults

To restore the BIOS to default settings, select this field then press <Enter>. A dialog box will appear. Confirm by selecting Yes.

Appendix A: Power Consumption

Power Consumption Management

Purpose

The purpose of the power consumption test is to verify the power dissipation of system, and the loading of power supply.

Test Equipment

PROVA CM-07 AC/DC CLAMP METER

Device Under Test

DUT: NISE105

CPU: Intel® Atom™ processor E3826 dual core, 1.46GHz

Memory: Transcend 4GB DDR3 SODIMM (TS512MSK64W6H)

HDD: SATA2 HDD 2.5 40GB 5400RPM (ST940817SM)

CFast: Transcend CFast 32GB (TS32GCFX500I)

Power Supply: LABORATORY DC POWER SUPPLY GWINSTEK GPC-60300

Add-on Card: MINI PCIE CARD 8790V

CPU Cooler: NISE105CPU HEATSINK SHYUNG SHUHN

System FAN: N/A

Keyboard: Microsoft Wired Keyboard 600

Mouse: Microsoft Basic Optical Mouse

Test Procedure

1. Power up the DUT, boot into Windows 8 x32 Pro
2. Entering standby mode (HDD power down)
3. Measure the power consumption and record it.
4. Run Burn-in test program to apply 100% full loading
5. Measure the power consumption and record it.

Test Data

	Sys #1	Sys #1
	+12V	+24V
Full-Loading Mode	2.03A	1.11A
Total	24.36W	26.64W
Standby S3Mode	0.93A	0.49A
Total	11.16W	11.76W

Appendix B: GPIO Programming Guide

GPIO (General Purpose Input/Output) pins are provided for custom system design. This appendix provides definitions and its default setting for the ten GPIO pins. The pin definition is shown in the following table:

Pin	GPIO mode	PowerOn Default	Address	Pin	GPIO mode	PowerOn Default	Address
1	VCC	-	-	2	GND	-	-
3	GPO0	Low	A03h (Bit6)	4	GPIO	High	A03h (Bit1)
5	GPO1	Low	A02h (Bit5)	6	GP11	High	A05h (Bit5)
7	GPO2	Low	A07h (Bit0)	8	GP12	High	A05h (Bit4)
9	GPO3	Low	A07h (Bit1)	10	GP13	High	A00h (Bit1)

Control the GPO 0/1/2/3 level from I/O port A03h bit6/ A02h bit5/ A07h bit0/ A07h bit1.
The bit is Set/Clear indicated output High/Low

GPIO programming sample code

```
#define GPO0    (0x01 << 6)
#define GPO1    (0x01 << 5)
#define GPO2    (0x01 << 0)
#define GPO3    (0x01 << 1)

#define GPO0_HI    outputb(0xA03, GPO0)
#define GPO0_LO    outputb(0xA03, 0x00)
#define GPO1_HI    outputb(0xA02, GPO1)
#define GPO1_LO    outputb(0xA02, 0x00)
#define GPO2_HI    outputb(0xA07, GPO2)
#define GPO2_LO    outputb(0xA07, 0x00)
#define GPO3_HI    outputb(0xA07, GPO3)
#define GPO3_LO    outputb(0xA07, 0x00)
void main(void)
{
    GPO0_HI;
    GPO1_LO;
    GPO2_HI;
    GPO3_LO;
}
```

Appendix C: Watchdog Timer Setting

ITE8783 WatchDog Programming Guide

```
#define SUPERIO_PORT 0x2E
#define WDT_SET      0x72
#define WDT_VALUE    0x73

void main(void)
{
    #Enter SuperIO Configuration
    outputb(SUPERIO_PORT, 0x87);
    outputb(SUPERIO_PORT, 0x01);
    outputb(SUPERIO_PORT, 0x55);
    outputb(SUPERIO_PORT, 0x55);

    # Set LDN
    outputb(SUPERIO_PORT, 0x07);
    outputb(SUPERIO_PORT+1, 0x07);

    # Set WDT setting
    outputb(SUPERIO_PORT, WDT_SET);
    outputb(SUPERIO_PORT+1, 0x90);           # Use the second
                                           # Use the minute, change value to 0x10

    # Set WDT sec/min
    outputb(SUPERIO_PORT, WDT_VALUE);
    outputb(SUPERIO_PORT+1, 0x05);         #Set 5 seconds
}
```