



Building the Digital Infrastructure



NEXCOM

NISE 3110 User Manual

Version 1.6

February, 2009

Copyright Notice

Copyright © 2006 NEXCOM

All rights reserved. No part of this manual may be reproduced, transmitted, transcribed, stored in a retrieval system, or translated into any language or computer language, in any form or by any means (electronic, mechanical, photocopying, recording, or otherwise), without the express written permission of NEXCOM. Information provided in this manual is intended to be accurate and reliable. However, the original manufacturer assumes no responsibility for its use, nor for any infringements upon the rights of third parties that may result from such use.

Acknowledgements

Intel and Pentium are trademarks of Intel Corporation.

Microsoft Windows® is a registered trademark of Microsoft Corp.

All other product names or trademarks are properties of their respective owners.

Declaration of Conformity

CE

This product has passed the CE test for environmental specifications when shielded cables are used for external wiring. We recommend the use of shielded cables. Please contact your local supplier for ordering information.

This product has passed the CE test for environmental specifications. Test conditions for passing included the equipment being operated within an industrial enclosure. In order to protect the product from being damaged by ESD (Electrostatic Discharge) and EMI leakage, we strongly recommend the use of CE-compliant industrial enclosure products.

FCC Class A

This equipment has been tested and found to comply with the limits for a Class A digital device, pursuant to part 15 of the FCC Rules. These limits are designed to provide reasonable protection against harmful interference when the equipment is operated in a commercial environment.

This equipment generates, uses, and can radiate radio frequency energy and, if not installed and used in accordance with the instruction manual, may cause harmful interference to radio communications. Operation of this equipment in a residential area is likely to cause harmful interference in which case the user will be required to correct the interference at his own expense.

Installation Suggestions

Ensure you have a stable, clean working environment. Dust and dirt can get into components and cause a malfunction. Use containers to keep small components separated.

Adequate lighting and proper tools can prevent you from accidentally damaging the internal components. Most of the procedures that follow require only a few simple tools, including the following:

- A Phillips screwdriver

- A flat-tipped screwdriver

- A grounding strap

- An anti-static pad

Using your fingers can disconnect most of the connections. It is recommended that you do not use needlenose pliers to disconnect connections as these can damage the soft metal or plastic parts of the connectors.

Handling Precautions

- ✘ Always disconnect the unit from the power outlet whenever you are installing or fixing a component inside the chassis.
- ✘ If possible, always wear a grounded wrist strap when you are installing or fixing a component inside the chassis. Alternatively, discharge any static electricity by touching the bare metal chassis of the unit case, or the bare metal body of any other grounded appliance.
- ✘ Hold electronic circuit boards by the edges only. Do not touch the components on the board unless it is necessary to do so. Do not flex or stress the circuit board.
- ✘ Use the correct screws and do not overly tighten them.
- ✘ Keep the original packaging and static-protective bag in case the unit has to be returned.

NEXCOM RMA Policy

1. Warranty Period

NEXCOM manufactures products that are new or equivalent to new in accordance with industry standard. NEXCOM warrants that products will be free from defect in material and workmanship for 24 months beginning on the date of invoice by NEXCOM. HCP series products (Blade Server) which are manufactured by NEXCOM are covered by a three year warranty period.

2. RMA (Return Merchandise Authorization)

- ✘ Customers shall enclose the “NEXCOM RMA Service Form” with the returned packages.
- ✘ Customers must collect all the information about the problems encountered and note anything abnormal or, print out any on-screen messages, and describe the problems on the “NEXCOM RMA Service Form” for the RMA number apply process.
- ✘ Customers can send back the faulty products with or, without accessories (manuals,cable, etc.) and any unnecessary components from the card, such as CPU and RAM.
If the components were suspected as part of the problems, please note clearly that which components are included. Otherwise, NEXCOM is not responsible for the devices/parts.
- ✘ Customers are responsible to for the safe packaging of defective products are durable enough to be resistant against further damage and deterioration during transportation. In case of damages occurred during the transportation, the repair is treated as “Out of Warranty.”

- ✘ 2.5 Any products returned by NEXCOM to other locations besides the customers' site will bear an extra charge and will be billed to the customer.

3. Repair service charges for out of warranty products

NEXCOM will charge for out of warranty products in two categories, one is basic diagnostic fee and another is component (product) fee.

System level

- ✘ Component fee: NEXCOM will only charge for main components, such as SMD chip, BGA chip, etc. Passive components will be repaired for free, ex: resistor, capacitor.
- ✘ Items will be replaced with NEXCOM products if the original one is not able to be repaired. Ex: motherboard, power supply, etc.
- ✘ Replaced with 3rd party products if needed.
- ✘ If RMA goods can not be repaired, NEXCOM will return it to customer without any charge.

Board level

- ✘ Component fee: NEXCOM will only charge for main components, such as SMD chip, BGA chip, etc. Passive components will be repaired for free, ex: resistors, capacitors.
- ✘ If RMA goods can not be repaired, NEXCOM will return it to customer without any charge.

Global Service Contact Information

Headquarters

NEXCOM International Co. Ltd.
18F, No.716, Chung-Cheng Road Chung-Ho City,
Taipei County 235, Taiwan, R.O.C.
Tel: 886-2-8228-0606
Fax: 886-2-8228-0501
Email: sales@nexcomcom.tw
Website: www.nexcom.com.tw

USA

NEXCOM USA
3758, Spinnaker Court, Fremont, CA 94538, US A.
Tel: 1-510-656-2248
Fax: 1-510-656-2158
Email: sales@nexcom.com
Website: www.nexcom.com

Europe

NEXCOM UK
10 Vincent Avenue, Crownhill
Milton Keynes, Buckinghamshire
MK8 0AB, United Kingdom
Tel: 44-(0)-1908-21 88 77
Fax: 44-(0)-1908-21 88 67
Email: sales@nexcomuk.co.uk
Website: www.nexcomuk.co.uk

Japan

NEXCOM Japan
10F, Nakagin-Shiroyama Building,
8-16-13 Ginza Chuou-Ku,
Tokyo, Japan 104-0061
Tel: 81-3-3524-4250
Fax: 81-3-3524-4252
Email: sales@nexcom-jp.com
Website: www.nexcom-jp.com

China

NEXCOM China
Room 301, Block E, Power Creative Building,
No.1 Shangdi East Rd.
Haidian District Beijing, 10085, China
Tel: 86-10-5885-6655
Fax: 86-10-5885-1006
Email: sales@nexcom.cn
Website: www.nexcom.cn

RoHS Compliance



NEXCOM RoHS Environmental Policy and Status Update. Nexcom is a global citizen for building the digital infrastructure. We are committed to providing green products and services, which are compliant with European Union RoHS (Restriction on Use of Hazardous Substance in Electronic Equipment) directive 2002/95/EU, to be your trusted green partner and to protect our environment.

RoHS restricts the use of Lead (Pb) < 0.1% or 1,000ppm, Mercury (Hg) < 0.1% or 1,000ppm, Cadmium (Cd) < 0.01% or 100ppm, Hexavalent Chromium (Cr6+) < 0.1% or 1,000ppm, Polybrominated biphenyls (PBB) < 0.1% or 1,000ppm, and Polybrominated diphenyl Ethers (PBDE) < 0.1% or 1,000ppm.

In order to meet the RoHS compliant directives, NEXCOM has established an engineering and manufacturing task force in to implement the introduction of green products. The task force will ensure that we follow the standard NEXCOM development procedure and that all the new RoHS components and new manufacturing processes maintain the highest industry quality levels for which NEXCOM are renowned.

The model selection criteria will be based on market demand. Vendors and suppliers will ensure that all designed components will be RoHS compliant.

How do you recognize NEXCOM RoHS Products?

For existing products where there are non-RoHS and RoHS versions, the suffix “(LF)” will be added to the compliant product name.

For example, PEAK 7220VL2G RoHS version will become PEAK 7220VL2G(LF). All new product models launched after January 2006 will be RoHS compliant.

They will use the usual NEXCOM naming convention.

For example, PEAK 870VL2, NBP14570, EBC 420 etc. All RoHS compliant model and component manufacturing part numbers will be suffixed “X00”

Manual Revision History

Revision	Date	Description
1.0	Sep., 07	First Edition, V1.0
1.1	Nov. 07	Add Appendix C “power consumption”
1.2	Feb.,08	Correct P28 GPIO pin definition (J11)
1.3	March, 08	Add the Appendix E: Display Setting Modify the Appendix B: GPIO Programming guide (add the note for SPC150)
1.4	July.,08	Add Appendix F: “IEGD installation guide” to resolve no display issue
1.5	Jan.,09	Add Appendix G: Award BIOS Setup
1.6	Feb. 09	Add DB44 to DB9 COM cable connector pin definition



Table of Content

- ✘ Copyright Notice..... 2
- ✘ Acknowledgements..... 2
- ✘ Declaration of Conformity..... 2
- ✘ Installation Suggestions 2
- ✘ Handling Precautions 3
- ✘ NEXCOM RMA Policy..... 4
- ✘ Global Service Contact Information 5
- ✘ RoHS Compliance 6
- ✘ Manual Revision History 6
- ✘ Table of Content..... 8
- Chapter 1 General Information 10**
- ✘ 1.1 Product Overview 11
- ✘ 1.2 Block Diagram..... 11
 - Figure 1.1 : Block Diagram of EBC 576 11
- ✘ 1.3 Specifications..... 12
- ✘ 1.4 Ordering Information 13
- ✘ 1.5 Packing Materials Checklist 13

- ✘ 1.6 Board Layout 14
 - Figure 1.2 Top View ofr the EBC 576 14
- ✘ 1.7 Dimension Drawing 15
 - Figure 1.3: Dimension drawing of EBC 576 15
 - Figure 1.4 Dimension drawing of NISE 3110 16
- Chapter 2 Jumper Setting 17**
- ✘ 2.1 Setting Jumpers 18
 - Table 2.1 Setting Jumpers 18
- ✘ 2.2 PCI Device interrupt and BUS Assignments 18
- ✘ 2.3 Location of Jumpers 19
 - Figure 2-1: Jumper Location of EBC 576..... 19
- ✘ 2.4 Definition of Jumpers 20

Appendix A-Watchdog Timer	33
✕ Watchdog Timer Common library	34
Appendix B-GPIO Programming Guide	36
Appendix C-Power Consumption	38
Appendix D-Installation Guide	40
✕ D.1 Handling Precautions.....	41
✕ D.2 Packing List	41
✕ D.3 Installation	42
1.Open Top Cover.....	42
2.Install/Remove CPU.....	42
3. Install/Remove RAM module	44
4.Close Top Cover	44
5.Open Bottom Cover	44
6.Install HDD	45
7.Close Bottom Cover.....	45
Appendix E-Display Seting	46
Appendix F-IEGD Installation Guide.....	48
Appendix G-Award BIOS Setup	51

Chapter 1 General Information

NECOM

Fan-less BOX Computer **NISE 3110**

1.1 Product Overview

Featuring Intel 945GME & ICH7 chipsets, the NISE 3110 fan-less box computer supports Intel's Core 2 Duo /Celeron M processor with 533/667 MHz FSB and DDR2 667/533 memory. The rugged NISE 3110 fan-less box computer is designed for space-critical application requires extreme reliability, low-power consumption and versatile I/O configuration. For added flexibility, the NISE 3110 also boasts three RS232 ports, one RS232/422/485 port and one PCI expansion slot.

For data storage, the NISE 3110 provides one CompactFlash socket and one 2.5" HDD drive bay. The System supports ATX mode power feature and can accept a wide range of power supplies from 12 V DC to 30 V DC.

Housed in a compact 195 mm x 268 mm x 80 mm heavy-duty aluminum chassis, the NISE 3110 is designed for reliable, maintenance-free industrial computing. The NISE 3110 fan-less box computer offers a cost-effective solution for a multitude of mission-critical embedded computing applications in automation, machine control, and POS systems.

- ✘ Support Intel® Core 2 Duo / Core Duo/ Celeron® M processors
- ✘ Intel® 945GME Chipsets
- ✘ Dual 1000/100/10Mbps LAN ports
- ✘ 6 x USB2.0/ VGA / DVI/ 4 x SIO
- ✘ One PCI Expansion Slot

1.2 Block Diagram

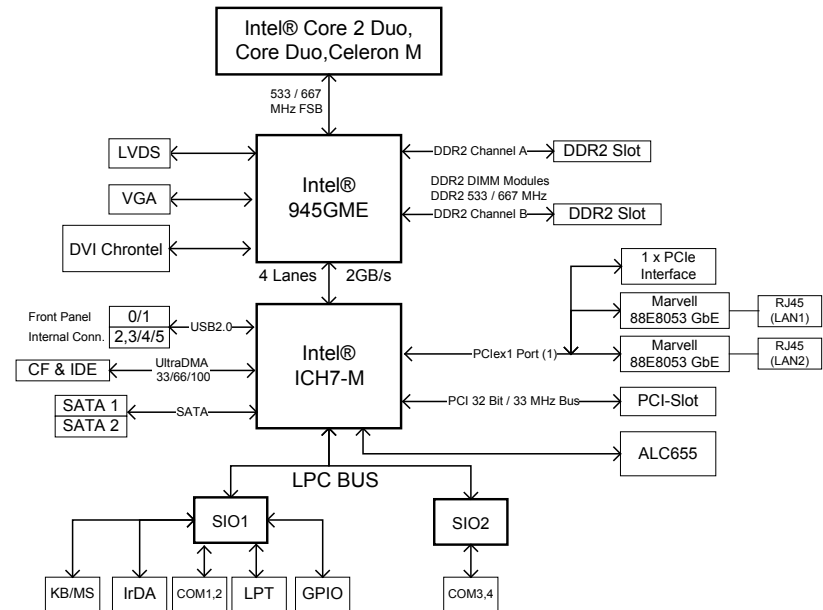

Figure 1.1 : Block Diagram of EBC 576

1.3 Specifications

Main Board

- ✘ EBC 576
- ✘ Support Intel® Core 2 Duo, Core Duo, Celeron® M family processors with 533/667 MHz
- ✘ Intel® Embedded Processor Reference List (Intel® Longevity CPU):
Core Duo Processor (T2500) 2.0G
Celeron® M 440 1.86G

Chipset

- ✘ Intel® 945GME Graphics Memory Controller Hub (GMCH)
- ✘ Intel® 82801 GBM ICH7 Mobile (ICH7-M)

Main Memory

- ✘ 2 x 240 pin DDR2 533/667 DIMM sockets, up to 2 GB unbuffered non-ECC DDR SDRAM (Max. 3G Capacity supported)

Expansion Slot

- ✘ Supports one 32-bit/ 33MHz PCI card
- ✘ PCI Length support:
160 mm (When 2.5" HDD installed)
240 mm (When no HDD is installed)

I/O Interface-Front

- ✘ Customized logo(Optional)
- ✘ HDD Access/Power/LAN status LEDs
- ✘ 2 x USB 2.0 ports
- ✘ ATX power on/off switch

I/O Interface-Rear

- ✘ 2 x PS/2 connectors (KB/MS)
- ✘ 1 x VGA connector
- ✘ 4 x USB 2.0 ports
- ✘ 2 x GbE LAN Ports
- ✘ 4 x Serial Ports, with 1x DB44 connector (Three ports support RS232, One port supports RS232/422/485)
- ✘ 1 x DVI interface
- ✘ 1 x Mic-in and 1 x Speaker-out
- ✘ 1 x 2-pin connector output for remote power on/off switch
- ✘ DC-in power connector for +12V ~+30V DC power input

Device

- ✘ 1 x On-board CompactFlash socket
- ✘ 1 x Internal 2.5" HDD drive bay

Power Input

- ✘ DC to DC power designed for on-board support of 12 to 30 VDC
(Max: 120 Watts)
- ✘ 1 x External 120 W AC adapter
Power input: 100 to 240 V AC 2 A 50/60 Hz
Power output: 19 VDC

Dimensions

- ✘ 195 mm (W) x 268 mm (D) x 80 mm (H) (7.6" x 10.5" x 3.1")

Construction

- ✘ Aluminum chassis with fan-less design

Environment

- ✘ Operating temperature:
Ambient with air flow : 0°C to 40°C (CPU loading: 70% less continently)
- ✘ NISE 3110 Tcase (Surface Temperature of Chassis)
5°C to 50°C (W/HDD)
-10°C to 55°C (W/CF card only)
- ✘ Storage temperature: -20°C to 80°C
Relative humidity: 10% to 90% (Non-condensing)

Certifications

- ✘ CE approval
- ✘ FCC

1.4 Ordering Information

Barebone

NISE 3110 (P/N: 10J0031100X0) RoHS Compliant

Intel® Core 2 Duo, Core Duo, Celeron® M Fanless Bare-Bone System, with one PCI expansion slot

1.5 Packing Materials Checklist

Description	Q'ty
Power Adapter 120W	1
Power Connector 2P	1
COM cable (1 x 44 pin connector to 4 x DB9 ports)	1
IDE Cable	1
EBC 576 CD Driver	1
EBC 576 Quick Reference Guide	1
Silicone Heatsink Compound	1

1.6 Board Layout

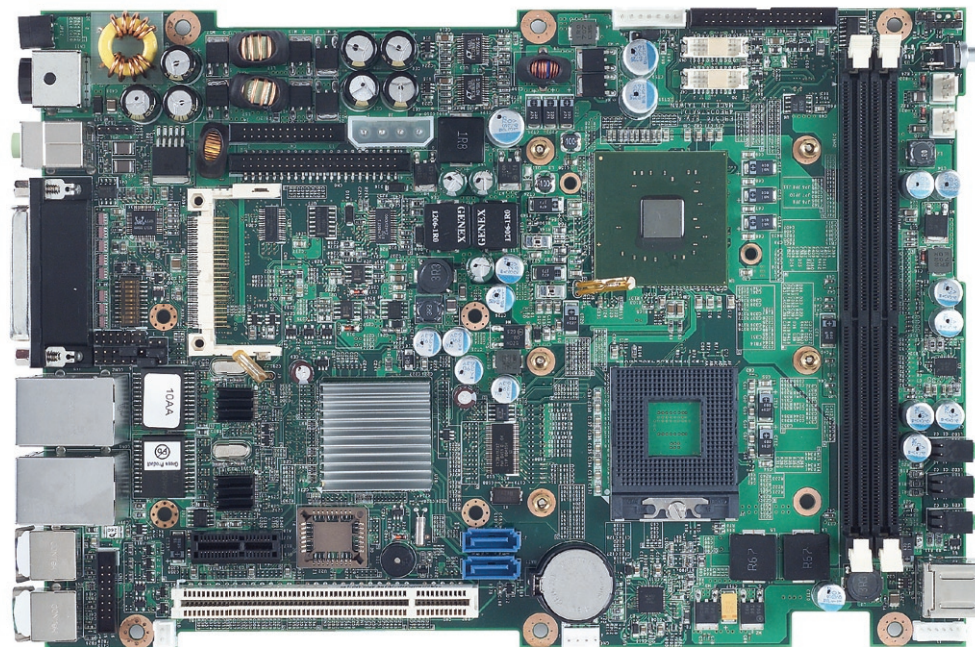

Figure 1.2 Top View of the EBC 576

1.7 Dimension Drawing

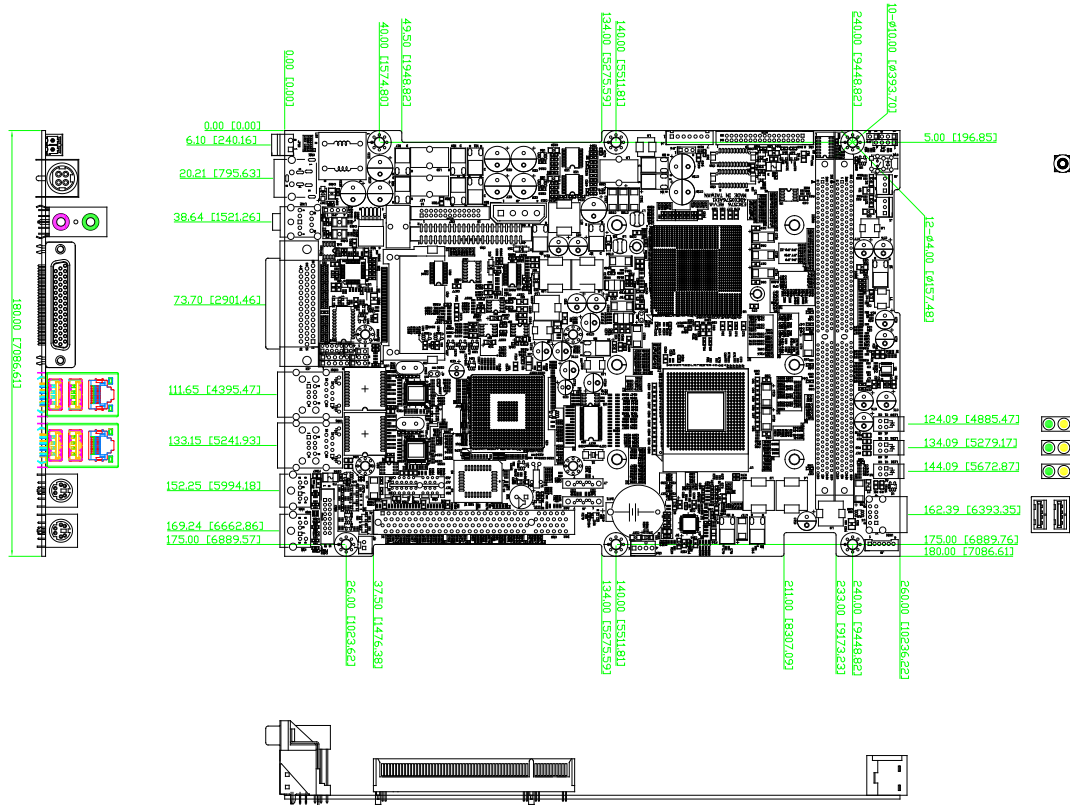

Figure 1.3: Dimension drawing of EBC 576

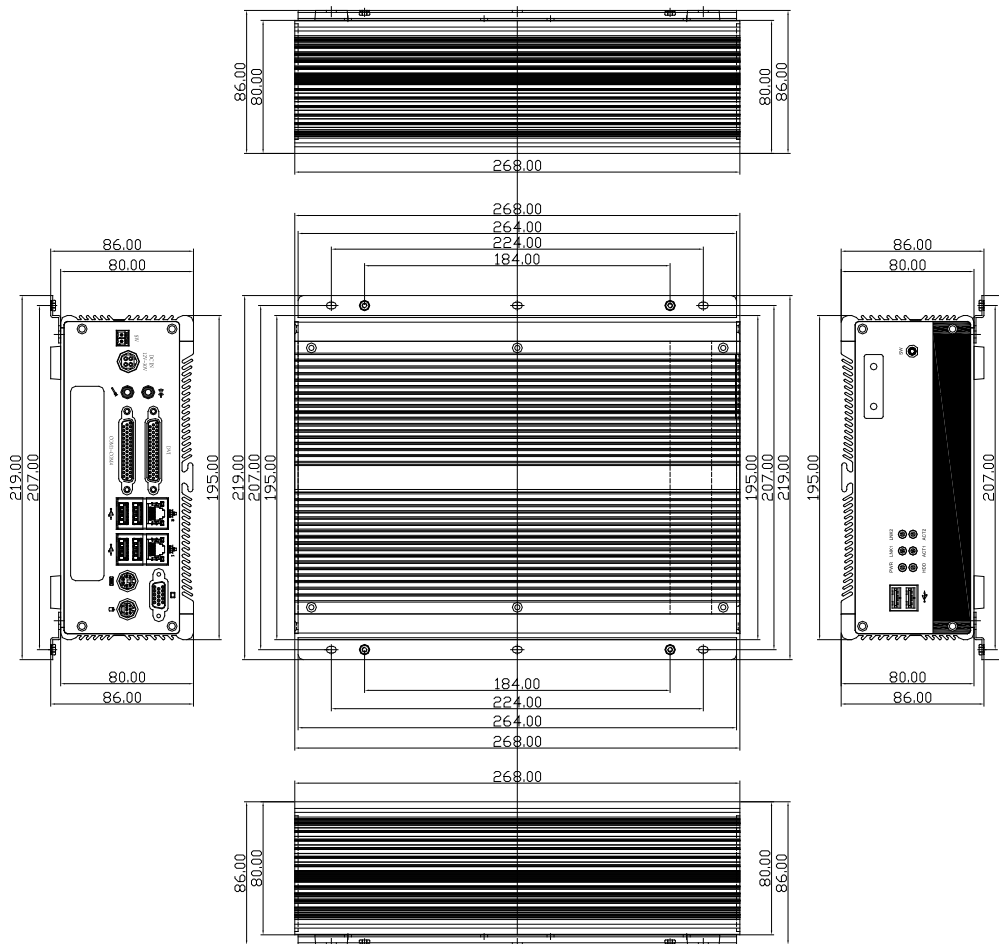

Figure 1.4 Dimension drawing of NISE 3110

Chapter 2 Jumper Setting

NECOM

Fan-less BOX Computer **NISE 3110**

2.1 Setting Jumpers

A jumper is the simplest kind of electric switch. It consists of two metal pins and a cap. When setting the jumpers, ensure that the jumper caps are placed on the correct pins. When the jumper cap is placed on both pins, the jumper is SHORT. If you remove the jumper cap, or place the jumper cap on just one pin, the jumper is OPEN. Please see the following illustrations

The illustrations on the right show a 2-pin jumper. When the jumper cap is placed on both pins, the jumper is SHORT. If you remove the jumper cap, or place the jumper cap on just one pin, the jumper is OPEN.		
	Open (Off)	Short (On)
These illustrations show a 3-pin Jumper. Pins 1 and 2 are SHORT.		

Table 2.1 Setting Jumpers

2.2 PCI Device interrupt and BUS Assignments

	Configuration BUS/DEVIC/FUNCTION	PCI INT#	REQ# /GNT#
PCI Slot1	1 / 17 / 0 1 / 18 / 0	A,B,C,D D,A,B,C	0,1

2.3 Location of Jumpers

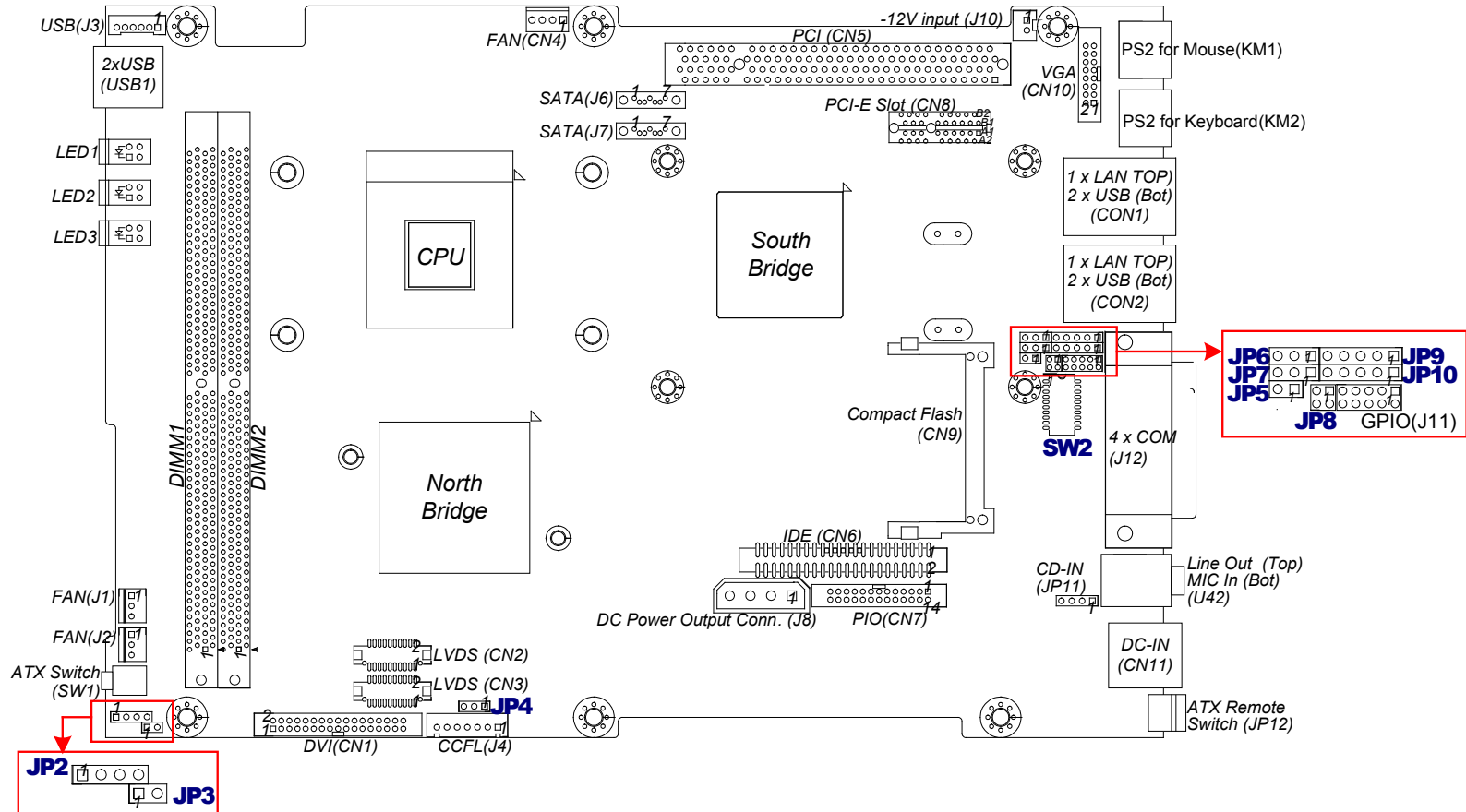
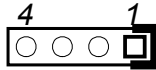

Figure 2-1: Jumper Location of EBC 576

2.4 Definition of Jumpers

✧ JP2: ATX power Switch (1x4 pin header,2.54mm)



PIN	Def.	PIN	Def.	PIN	Def.
1	ATX Power on	2	ATX Power on	3-4	GND

✧ JP3: Hardware Reset (1x2 pin header,2.54mm)



PIN	Def.	PIN	Def.
1	Reset	2	GND

✧ JP4:Panel Power Select (1x3 pin header,2.54mm)

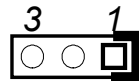

PIN	Def.
1	VCC5
2	Panel Power
3	VCC3

✧ JP5: I²C (1x2 pin header,2.54mm)



Pin	Def.	Pin	Def.
2	Data	1	CLK

✧ JP6: CMOS Status Select (1x3 pin header,2.54mm)

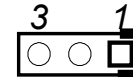

Pin	Status	Function
1-2	Short*	Normal Operation
2-3	Short	Clear CMOS DATA

✧ JP7: CF Master / Slave Selection (1x3 pin header,2.54mm)

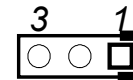

<1-2 pin short= Master / **2-3 pin short= Slave>

PIN	Def.	PIN	Def.	PIN	Def.
3	Slave (GND)	2	CF_CSEL	1	Master (VCC5)

✧ JP8: GPI/O Programming LED (2x2 pin header,2.0mm)

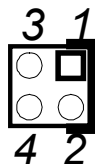

Pin	Def.	Pin	Def.
3	GP21	1	GP20
4	GND	2	GND

✧ JP9: IR Interface (1x5 pin header,2.54mm)

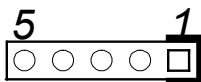

PIN	Def.	PIN	Def.	PIN	Def.	PIN	Def.	PIN	Def.
5	IRTX	4	GND	3	IRRX	2	CIRRX	1	VCC5

✧ JP10: RI# Signal Power Select (1x5 pin header,2.54mm)

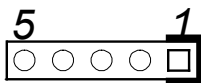

<1-2 short: RI Power = 5v / 3-4 short: RI Power=12V / **4-5 short: Normal >

PIN	Def.	PIN	Def.	PIN	Def.	PIN	Def.	PIN	Def.
5	SP_RI4	4	RI4	3	+12V	2	RI4	1	VCC5

✧ SW2: COM2 RS232/422/485 Select (2x10 DIP SWITCH)

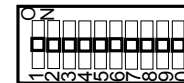

Mode	1	2	3	4	5	6	7	8	9	10
RS232*	OFF	OFF	OFF	ON	OFF	ON	OFF	OFF	OFF	OFF
RS422	OFF	OFF	ON	OFF	ON	OFF	ON	ON	ON	ON
RS485	ON	ON	OFF	ON	ON	OFF	OFF	OFF	OFF	ON

✧ JP11: CD-IN (1x4 pin header, 2.54mm)

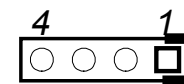

Pin.	Def.
1	CD-IN-L
2	AUDIO GND PWR
3	AUDIO GND PWR
4	CD-IN-R

✘ CN4:CPU FAN (1x4 pinWafer, 2.54mm)

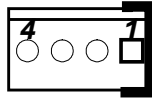

Pin.	Def.
1	GND
2	+12V
3	SENSE
4	FAN_CTRL

✘ J1/J2: SYSTEM FAN (1x 3 pin Wafer, 2.54mm)

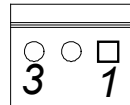

Pin.	Def.
1	GND
2	12V
3	SENSE

✧ CN1: DVI Interface (2x17 pin box header, 2.0mm)

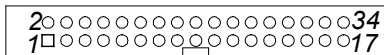

Pin.	Def.	Pin.	Def.
1	CAS_GND	18	HPDET
2	CAS_GND	19	DVI_DATA0#
3	DVI_DATA2#	20	DVI_DATA0
4	DVI_DATA2	21	CAS_GND
5	GND	22	NC
6	NC	23	NC
7	NC	24	GND
8	DDC_CLK	25	TLC
9	DDC_DATA	26	TLC#
10	NC	27	GND
11	DVI_DATA1#	28	GND
12	DVI_DATA1	29	NC
13	CAS_GND	30	NC
14	NC	31	NC
15	NC	32	CAS_GND
16	DVI_VCC	33	CAS_GND
17	CAS_GND	34	NC

✧ CN2/CN3: LVDS Connector (2x10 pin DF13)

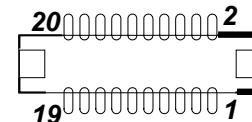

CN2			
Pin.	Def.	Pin.	Def.
1	DDCCLK	11	LA_CLK_P
2	DDC_DATA	12	LA_DATAN1
3	VDD	13	LA_CLK_N
4	LA_DATAP0	14	GND
5	NC	15	GND
6	LA_DATAN0	16	BACKLIGHT
7	NC	17	LA_DATAP2
8	VDD	18	BACKLIGHT
9	GND	19	LA_DATAN2
10	LA_DATAP1	20	GND

CN3			
Pin.	Def.	Pin.	Def.
1	DDCCLK	11	LB_CLK_P
2	DDC_DATA	12	LB_DATAN1
3	VDD	13	LB_CLK_N
4	LB_DATAP0	14	GND
5	NC	15	GND

6	LB_DATAN0	16	BACKLIGHT
7	NC	17	LB_DATAP2
8	VDD	18	BACKLIGHT
9	GND	19	LB_DATAN2
10	LB_DATAP1	20	GND

✧ CN5: PCI-SLOT (Standard PCI 32 Bit Connector)

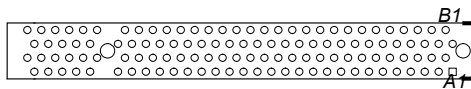

Pin.	Def. (Side B)	Def. (Side A)
1	-12V	GND
2	GND	+12V
3	GND	+5V
4	NC	+5V
5	+5V	+5V
6	+5V	Interrupt A#
7	Interrupt B#	Interrupt C#
8	Interrupt D#	+5V
9	Connector capacitance 10pf to Ground	NC
10	Request#1	+5V
11	Connector capacitance 10pf to Ground	NC
12	GND	GND
13	GND	GND
14	Clock1	Grant#1
15	GND	Reset#

16	Clock0	+5V
17	GND	Grant#0
18	Request#0	GND
19	+5V	Power Management Event#
20	Address and Data 31	Address and Data 30
21	Address and Data 29	+3.3V
22	GND	Address and Data 28
23	Address and Data 27	Address and Data 26
24	Address and Data 25	GND
25	+3.3V	Address and Data 24
26	Command & Byte Enable#3	Initialization Device Select
27	Address and Data 23	+3.3V
28	GND	Address and Data 22
29	Address and Data 21	Address and Data 20
30	Address and Data 19	GND
31	+3.3V	Address and Data 18
32	Address and Data 17	Address and Data 16
33	Command & Byte Enable#2	+3.3V
34	GND	Frame#
35	Initiator Ready#	GND
36	+3.3V	Target Ready#
37	Device Select#	Device Select#
38	GND	GND
39	Lock#	Lock#
40	Parity Error#	Parity Error#

41	+3.3V	+3.3V
42	System Error#	System Error#
43	+3.3V	+3.3V
44	Command & Byte Enable#1	Command & Byte Enable#1
45	Address and Data 14	Address and Data 14
46	GND	GND
47	Address and Data 12	Address and Data 12
48	Address and Data 10	Address and Data 10
49	GND	GND
50	Connector Key	Connector Key
51	Connector Key	Connector Key
52	Address and Data 8	Address and Data 8
53	Address and Data 7	Address and Data 7
54	+3.3V	+3.3V
55	Address and Data 5	Address and Data 5
56	Address and Data 3	Address and Data 3
57	GND	GND
58	Address and Data 1	Address and Data 1
59	+5V	+5V
60	+5V	+5V
61	+5V	+5V
62	+5V	+5V

✧ CN7: Parallel port (2x13 pin box header)

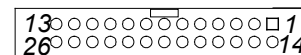

Pin.	Def.	Pin.	Def.
1	STB#	14	AFD-
2	PD0	15	ERR-
3	PD1	16	INIT-
4	PD2	17	NC
5	PD3	18	GND
6	PD4	19	GND
7	PD5	20	GND
8	PD6	21	GND
9	PD7	22	GND
10	ACK-	23	GND
11	BUSY	24	GND
12	PE	25	GND
13	SLCT	26	NC

✧ CN8: PCI-E Slot

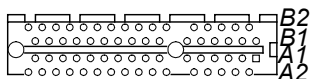

Pin.	Def. (Side B)	Def. (Side A)
1	+12 volt power	NC
2	+12 volt power	+12 volt power
3	Reserved	+12 volt power
4	Ground	Ground
5	SMBus clock	NC
6	SMBus data	NC
7	Ground	NC
8	+3.3 volt power	NC
9	NC	3.3v volt power
10	3.3VSB	3.3v volt power
11	WAKE#	PE_RESEET#
12	Reserved	Ground
13	Ground	REFCLK_P
14	TXP0	REFCLK_N
15	TXN0	Ground
16	Ground	RXP0
17	SDVO_CTRLCLK	RXN0
18	Ground	Ground

✧ CN9: Compact Flash Socket (Type 2)

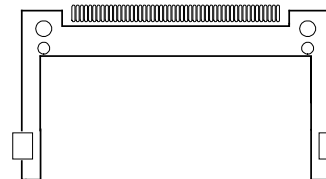

Pin.	Def.	Pin.	Def.
1	GND	2	SDD3A
3	SDD4A	4	SDD5A
5	SDD6A	6	SDD7A
7	SDCS#1	8	GND
9	GND	10	GND
11	GND	12	GND
13	VCC	14	GND
15	GND	16	GND
17	GND	18	SDA2A
19	SDA1A	20	SDA0A
21	SDD0A	22	SDD1A
23	SDD2A	24	NC
25	CF_CD2#	26	CF_CD1#
27	SDD11A	28	SDD12A
29	SDD13A	30	SDD14A
31	SDD15A	32	SDCS#3
33	NC	34	SDIOR#
35	SDIOW#	36	VCC

37	HDIRQ14	38	VCC
39	CF_SEL#	40	NC
41	IDERST#	42	SIORDY
43	SDREQ	44	SDDACK#
45	IDEACTP#	46	DIAG#
47	SDD8A	48	SDD9A
49	SDD10A	50	GND

✧ CN12(Reverse)/ CN6 (Obverse): IDE Connectoe (2x44 pin box heade,2.0mm)

<Note: CN12 and CN6 are co-layout>

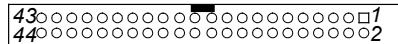

Pin.	Def.	Pin.	Def.
1	RESET	2	GND
3	DD7	4	DD8
5	DD6	6	DD9
7	DD5	8	DD10
9	DD4	10	DD11
11	DD3	12	DD12
13	DD2	14	DD13
15	DD1	16	DD14
17	DD0	18	DD15
19	GND	20	NC
21	REQ	22	GND
23	IOW	24	GND

25	IOR	26	GND
27	IO_CH_RDY	28	DIAG
29	DACK#,	30	GND
31	IRQ_R	32	NC
33	DA1	34	66DET
35	DA0	36	DA2
37	CS0	38	CS1
39	ACT	40	GND
41	VCC5	42	VCC5
43	GND	44	NC
41	VCC5	42	VCC5
43	GND	44	NC

✧ CN10: VGA Port (2x8 pin box header, 2.0mm)

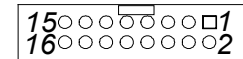

Pin.	Def.	Pin.	Def.
1	RED_VGA	9	VGA_VCC
2	GREEN_VGA	10	GND
3	BLUE_VGA	11	NC
4	NC	12	DATA_V
5	GND	13	HS_VGA
6	GND	14	VS_VGA
7	GND	15	CLK_V
8	GND	16	NC

✘ CN11: Power Jack 4 pins

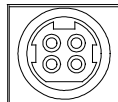

Pin	Def.	Pin	Def.
3-4	GND	1-2	DC-IN

✘ J3: Internal USB Connector (1x6 pin JST, 2.0mm)

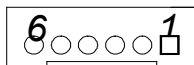

Pin.	Def.	Pin.	Def.
1	VCC	4	USB_1N
2	USB_ON	5	USB_1P
3	USB_OP	6	GND

✘ J4: CCFL (1x7 pin JST, 2.54mm)

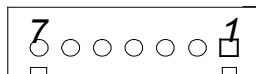

Pin.	Def.	Pin.	Def.
1	+5V	2	+12V
3	+12V	4	Brightness Ctrl
5	GND	6	GND
7	Backlight Enable		

✘ J8: DC Power output Connector (1x4-pin power jack, 5.08mm)

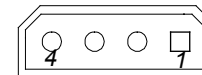

Pin.	Def.	Pin.	Def.	Pin.	Def.	Pin.	Def.
4	VCC5	3	GND	2	GND	1	+12v

✘ J10: External 12 power input connector (1x2 pin JST, 2.5mm)

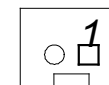

Pin.	Def.	Pin.	Def.
2	GND	1	-12V

✘ J11: External GPI/O Indicated LED (2x5 pin header, 2.0mm)

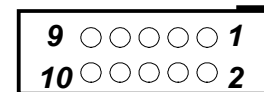

Pin.	Def.	Pin.	Def.
1	+5V	2	GND
3	GP20: Output	4	GP24: Input
5	GP21: Output	6	GP25: Input
7	GP22: Output	8	GP26: Input
9	GP23: Output	10	GP27: Input

✦ J6/J7: SATA Connector (Standard Serial ATAII 1.27mm connector)

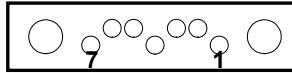

J6			
Pin.	Def.	Pin.	Def.
1	GND	2	TXP0
4	GND	3	TXN0
7	GND	5	RXN0
		6	RXP0
J7			
Pin.	Def.	Pin.	Def.
1	GND	2	TXP1
4	GND	3	TXN1
7	GND	5	RXN1
		6	RXP1

✦ CON1/ CON2: USB / LAN Port (RJ45 Jack combine with dual USB ports)

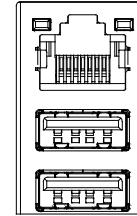

CON1-A:			
Pin.	Def.	Pin.	Def.
1	VCC	5	VCC
2	USB_2N	6	USB_3N
3	USB_2P	7	USB_3P
4	GND	8	GND
CON1-B:			
9	TX0P_E	19	VCC3
10	TX0N_E	20	LINK_E
11	TX1P_E	21	GND
12	TX2P_E	22	GND
13	TX2N_E	23	GND
14	TX1N_E	24	GND
15	TX3P_E	25	GND
16	TX3N_E	26	GND
17	ACT_E	27	GND
18	LINK_E	28	GND

CON2-A:			
Pin.	Def.	Pin.	Def.
1	VCC	5	VCC
2	USB_4N	6	USB_5N
3	USB_4P	7	USB_5P
4	GND	8	GND
CON2-B:			
9	TX0P_F	19	VCC3
10	TX0N_F	20	LINK_F
11	TX1P_F	21	GND
12	TX2P_F	22	GND
13	TX2N_F	23	GND
14	TX1N_F	24	GND
15	TX3P_F	25	GND
16	TX3N_F	26	GND
17	ACT_F	27	GND
18	LINK_F	28	GND

✧ U42: Audio Interface (Double layer Phone jack)

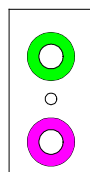

	Def.		Def.
GreenUpper	Line-Out	Pink Lower	MIC-In

✧ J12: Serial Interface (COM1~COM4, 44-pin D-SUB)

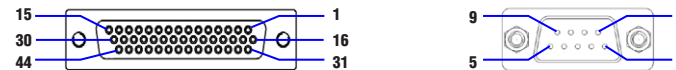

COM1 (RS-232) labelled "A" on DB9 cable connector					
DB44 Pin#	DB9 Pin#	Def.	DB44 Pin#	DB9 Pin#	Def.
1	1	DCD1	2	2	RXD1
3	3	TXD1	4	4	DTR1
5	5	GND	6	6	DSR1
7	7	RTS1	8	8	CTS1
9	9	RI1	10		GND
COM2 (RS-232) labelled "B" on DB9 cable connector					
DB44 Pin#	DB9 Pin#	Def.	DB44 Pin#	DB9 Pin#	Def.
11	1	DCD2	12	2	RXD2
13	3	TXD2	14	4	DTR2
15	5	GND	16	6	DSR2
17	7	RTS2	18	8	CTS2
19	9	RI2	20		GND
COM3 (RS-232) labelled "C" on DB9 cable connector					
DB44 Pin#	DB9 Pin#	Def.	DB44 Pin#	DB9 Pin#	Def.
21	1	DCD3	22	2	RXD3
23	3	TXD3	24	4	DTR3
25	5	GND	26	6	DSR3
27	7	RTS3	28	8	CTS3
29	9	RI3	30		GND
COM4 (RS-232) labelled "D" on DB9 cable connector					

DB44 Pin#	DB9 Pin#	Def.	DB44 Pin#	DB9 Pin#	Def.
31	1	DCD4	32	2	RXD4
33	3	TXD4	34	4	DTR4
35	5	GND	36	6	DSR4
37	7	RTS4	38	8	CTS4
39	9	RI4	40		GND
41		NC	42		NC
43		NC	44		NC

Note : pin 39 is defined as an external Power source, which can be selected for 5V or 12V by JP10

COM2 (RS-422) labelled "B" on DB9 cable connector

DB44 Pin#	DB9 Pin#	Def.	DB44 Pin#	DB9 Pin#	Def.
11	1	TXD-	12	2	TXD+
13	3	RXD+	14	4	RXD-
15	5	GND	16	6	RTS-
17	7	RTS#	18	8	CTS+
19	9	CTS-	20		GND

COM2 (RS-485) : labelled "B" on DB9 cable connector

DB44 Pin#	DB9 Pin#	Def.	DB44 Pin#	DB9 Pin#	Def.
11	1	TXD-	12	2	TXD+
		RXD-			RXD+
13	3	Reserved	14	4	Reserved
15	5	Reserved	16	6	Reserved
17	7	Reserved	18	8	Reserved
19	9	Reserved	20		Reserved

✧ KM1/ KM2 :P/S 2 Keyboard / Mouse (6-pin Mini DIMM)

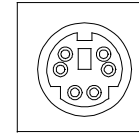

KM2 For Keyboard:

Pin.	Def.	Pin.	Def.
1	KB_DATA	2	NC
3	GND	4	KM_VCC
5	KB_CLK	6	NC

KM1 For Mouse:

Pin.	Def.	Pin.	Def.
1	LM_DATA	2	NC
3	GND	4	KM_VCC
5	LM_CLK	6	NC

✧ JP12: ATX Remote On / Off Switch (2 pin Tterminal port, 3.81mm)

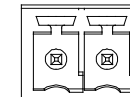

Pin.	Def.
1	GND
2	PWR_ON

✕ USB1: USB Port (Dual USB port)

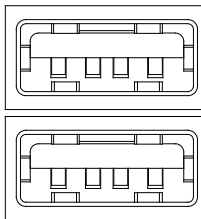

Pin.	Def.	Pin.	Def.
1	VCC	5	VCC
2	USB_1N	6	USB_ON
3	USB_1P	7	USB_OP
4	GND	8	GND

Appendix A-Watchdog Timer

NEXCOM

Fan-less BOX Computer **NISE 3110**

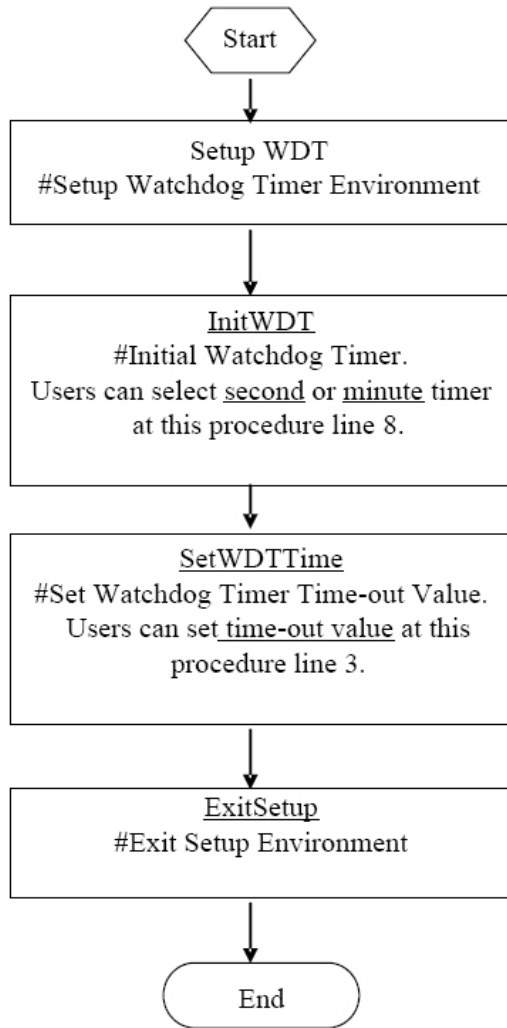

Watchdog Timer Common library

0	SetupWDT	PROC
1	mov	al,87h
2	out	2eh, al
3	mov	al,01h
4	out	2eh,al
5	mov	al,55h
6	out	2eh,al
7	out	2eh,al
8		
9	mov	al,07h
10	out	2eh,al
11	mov	al,07h
12	out	2fh,al
13	ret	
14	SetupWDT	ENDP

0	InitWDT	PROC
1	mov	al,71h
2	out	2eh,al
3	mov	al,30h
4	out	2fh,al
5		

6	mov	al,72h
7	out	2eh,al
8	mov	al,0c0h -Here!! set 0c0h for second, set 40h for minute
9	out	2fh,al
10	ret	
11	InitWDT	ENDP

0	SetWDTTime	PROC
1	mov	al,73h
2	out	2eh,al
3	mov	al,5-Here!! Set 5 sec. (time out vale: 0x00-0xff)
4	out	2fh,al
5	ret	
6	SetWDTTime	ENDP

0	ExitSetup	PROC
1	mov	al,02h
2	out	2eh,al
3	mov	al,02h
4	out	2fh,al
5	ret	
6	ExitSetup	ENDP

Appendix B-GPIO Programming Guide

NECOM

Fan-less BOX Computer **NISE 3110**

PIN	Description	PIN	Description
1	+5V	2	GND
3	GP20:OUTPUT	4	GP24:INPUT
5	GP21:OUTPUT	6	GP25:INPUT
7	GP22:OUTPUT	8	GP26:INPUT
9	GP23:OUTPUT	10	GP27:INPUT

IO ADDRESS : 801H

Bit0 : GP20

Bit1 : GP21

Bit2 : GP22

Bit3 : GP23

Bit4 : GP24

Bit5 : GP25

Bit6 : GP26

Bit7 : GP27

Note:

- GPIO Pin-20 on EBC576/NISE3110 has been programmed for Smart Panel Computer to indicate the system power status to SPC.
- GPIO Pin-20 signal level is controlled by BIOS, high defined as system power up and low defined as system shutdown with standby power.

*If GPIO slave input port: Reflects the incoming logic levels of the pins, regardless of whether the pin is defined as an input or output. Writes to this register[bit:7..4] have no effect.

*If GPIO slave output port: Controls the levels of the GPIO output pins defined as outputs. Bit values in this register[bit:3..0] have no effect on pins defined as inputs.

Read from this register reflects the saved value last written, not the actual pin value.

Appendix C-Power Consumption

NEXCOM

Fan-less BOX Computer **NISE 3110**

DC input 19V (System-only)	CPU Type: Intel Core 2 Duo T2500 2.0 GHz	
	19V	Total Watts
Full-Loading Mode	1.97A	37.43W
Light-Loading Mode (Idle Mode)	1.03A	19.57W
Standby Mode (S1: Power on Suspend)	0.99A	18.81W

DC input 19V (System-only)	CPU Type: Intel Celeron-M 440 1.86GHz	
	19V	Total Watts
Full-Loading Mode	1.62A	30.78W
Light-Loading Mode (Idle Mode)	1.30A	24.70W
Standby Mode (S1: Power on Suspend)	1.07A	20.33W

Test Criteria:

- ✘ Test configuration should include test board, HDD drive.
- ✘ Full loading mode should utilize CPU 100% with run Burn-in test program.
- ✘ Idle mode will utilize CPU loading below 5%, and there is no data or application running.

Appendix D- Installstion Guide

NEXCOM

Fan-less BOX Computer **NISE 3110**

D.1 Handling Precautions

- ✘ Always disconnect the unit from the power outlet whenever you are installing or fixing a component inside the chassis.
- ✘ If possible, always wear a grounded wrist strap when you are installing or fixing a component inside the chassis. Alternatively, discharge any static electricity by touching the bare metal chassis of the unit case, or the bare metal body of any other grounded appliance.
- ✘ Hold electronic circuit boards (such as the EBC575 board) by the edges only. Do not touch the components on the board unless it is necessary to do so. Do not flex or stress the circuit board.
- ✘ Use the correct screws and do not overly tighten them.
- ✘ Keep the original packaging and static-protective bag in case the unit has to be returned.

D.2 Packing List

Accessories

- ✘ Quick Reference Guide x 1
- ✘ COM Port Cable x 1
- ✘ 2-pin Phoenix power connector x1
- ✘ CD Driver x 1
- ✘ 120W Power Adapter x 1
- ✘ IDE cable x 1

D.3 Installation

1. Open Top Cover



- ✘ Step 1-1: Remove 6 screws from the top.

2. Install/Remove CPU

- ✘ Step 2-1: Unscrew 6 screws on heat sink

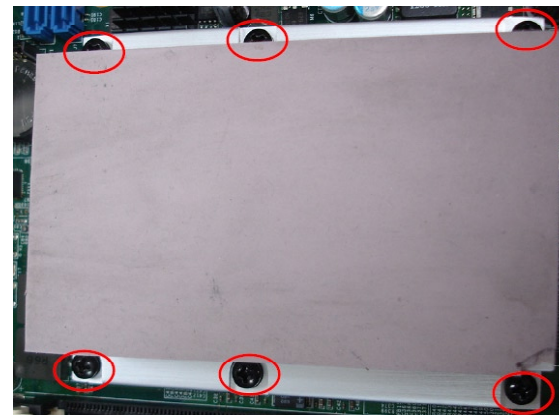

- ✘ Step 2-2: Pay attentions to CPU installation



✘ Step 2.3: Be aware that the beveled corner of the CPU as shown in the picture is aligned to the direction of the socket.

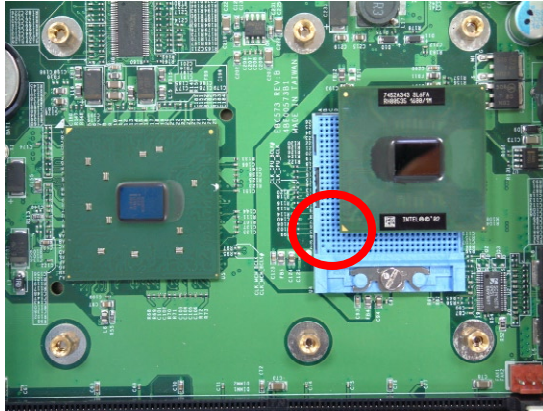

✘ Step 2.5: Insert heat sink silicon compound

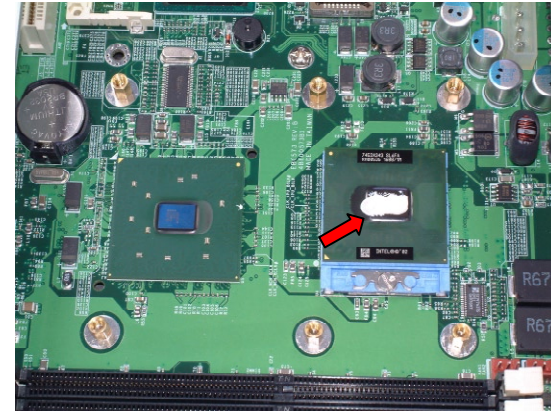

✘ Step 2.4: Secure the CPU

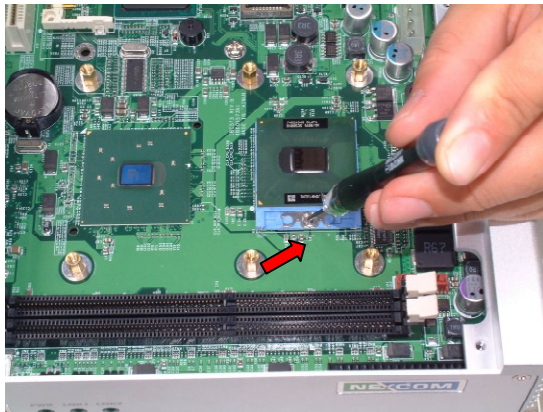

✘ Step 2.6: Lock the heat sink

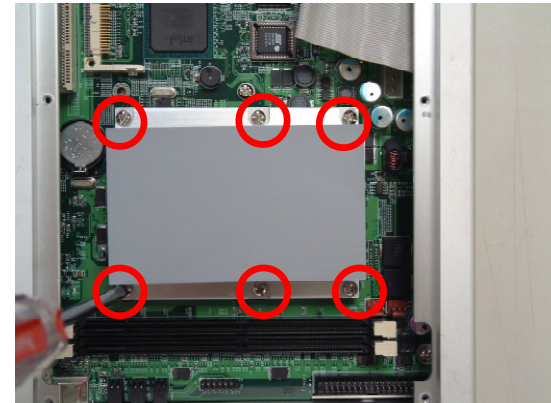

3. Install/Remove RAM module



✘ Step 3-1: Insert either 1 or 2 DDR

4. Close Top Cover



✘ Step 4-1: Secure the top cover with screws

5. Open Bottom Cover



✘ Step 5-1: Remove the screws on the bottom side

6. Install HDD

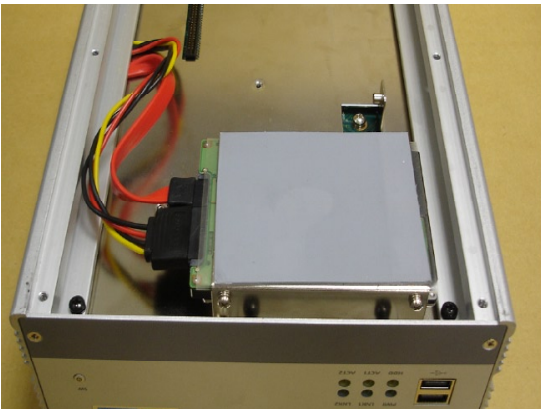

- ✘ Step 6-1: Unscrew HDD stand

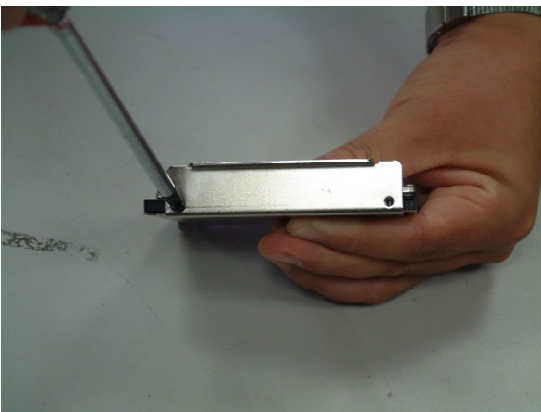

- ✘ Step 6-2: Secure 2.5" HDD



- ✘ Step 6-3: Place finished stand with HDD back to the chassis and make sure it is properly secured. Plug HDD cable and pay attention to SATA power cable and SATA cable at the right position.

7. Close Bottom Cover



- ✘ Step 7-1: Lock bottom cover with screws

Appendix E- Display Setting

NEXCOM

Fan-less BOX Computer **NISE 3110**

Since the chipset belongs to Intel mobile group, LVDS is the default of display. Once VGA port is not linked with monitor when power on the NISE system, LVDS will be the first display automatically afterwards. Follow below steps to select the VGA/DVI monitor as the default display for your need.

After setting, press "CTRL + ALT + F1" to enable monitor as the main display if have the same situation.

✘ Have NISE system linked with VGA/DVI monitor

✘ Select "Intel GMA Driver for Mobile" from Control Panel

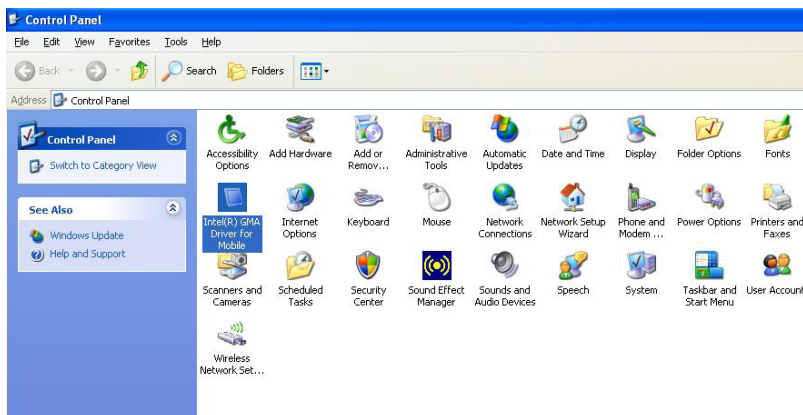

✘ Select "Monitor" from Display Devices

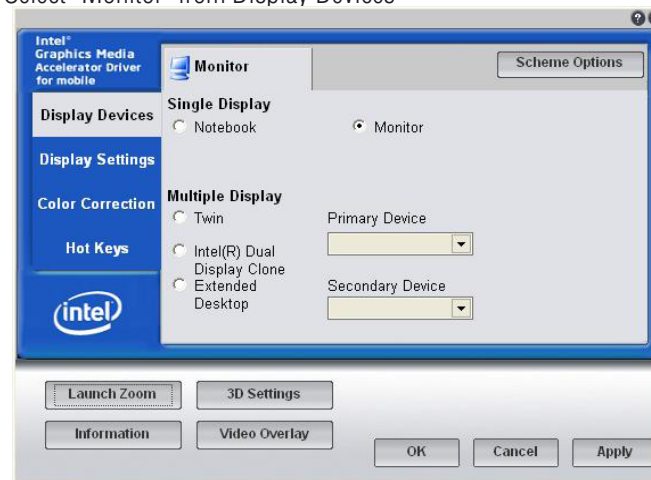

✘ Select "Enable Hot Keys" from Hot Keys

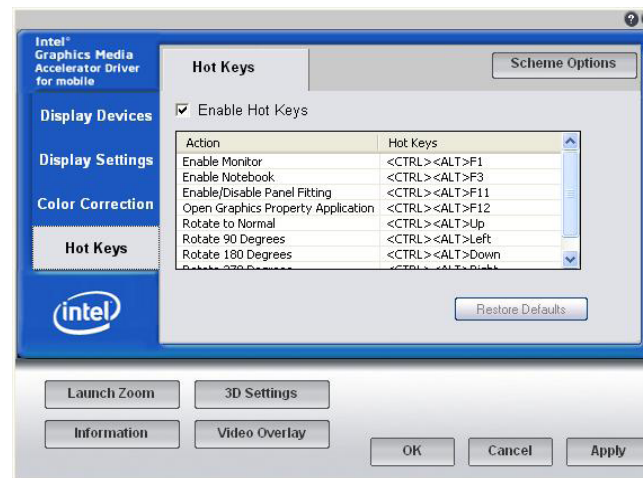

Appendix F- IEGD Installation Guide

NEXCOM

Fan-less BOX Computer **NISE 3110**

How to resolve no display:

If there is no monitor attached onto the VGA connector when the system is at startup stage, the chipset will disable the VGA signal output automatically. VGA signal can not be back no matter re-install OS or reconnect monitor.

The IEGD VGA driver can help to resolve no display issue in Windows XP and XPe OS. Please follow following IEGD driver installation guide:

- ✘ Step 1: Remove original graphic driver under Windows XP or Windows XPe.
- ✘ Step 2: After reboot, please set “Boot Display” to be “CRT+DVI” in BIOS setting.

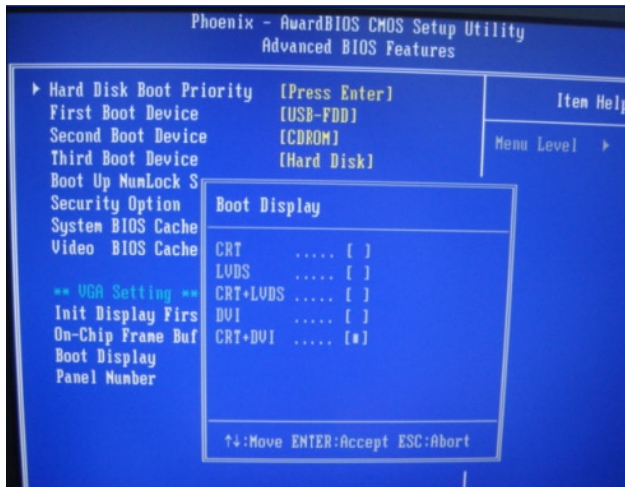

- ✘ Step 3: Uncompress the IEGD driver and run setup.exe in utility folder.

IEGD_8_0_Windows-For A2DVI2\IEGD_8_0_Windows\IEGD_8_0_Windows\Utilities

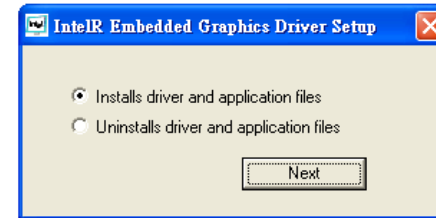

- ✘ Step-4: After driver installation, please reboot the system.
- ✘ Step-5: Press “Advanced” in Display Properties.

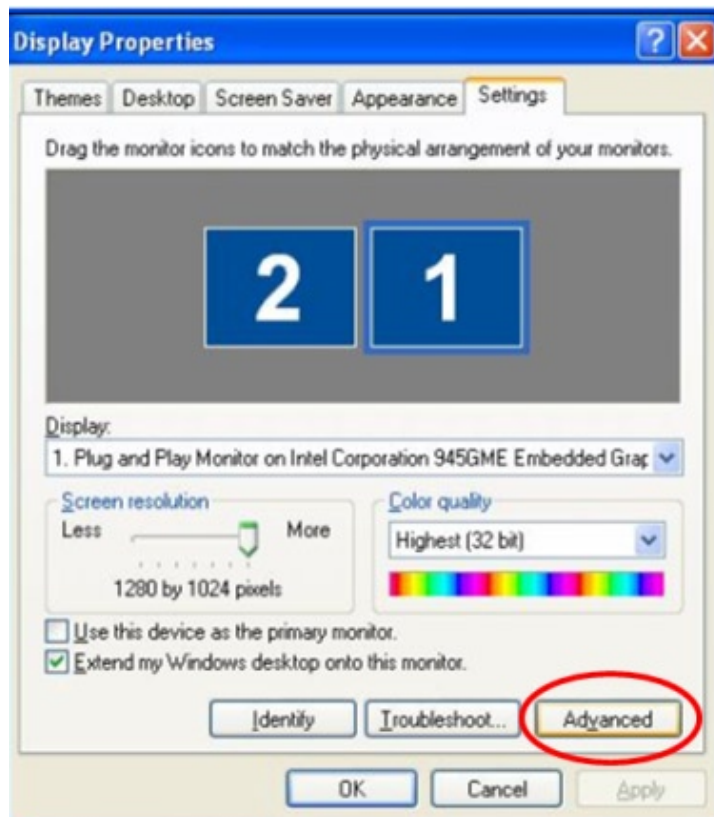

- ✘ Step-6: Select preferred Display Config:

945_DVI (single)
 945_CRT (single)
 945_DVI, 945_CRT (twin)
 945_DVI (clone) 945_CRT
 945_DVI (extend) 945_CRT

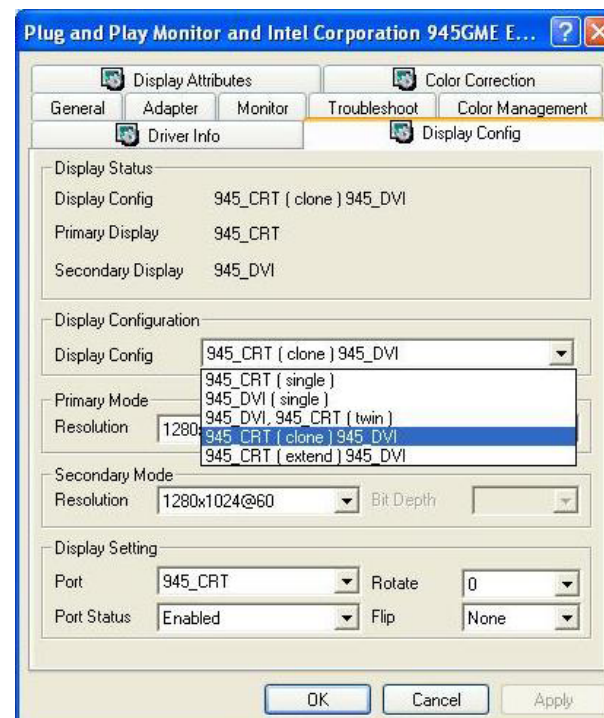

Appendix G- Award BIOS Setup

NECOM

Fan-less BOX Computer **NISE 3110**

This chapter explains how to use the BIOS Setup program for the EBC 576. The current BIOS setup pictures in the chapter are for reference only, which may change by the BIOS modification in the future. User can download any major updated items or reversion from NEXCOM web site <http://www.nexcom.com.tw>. If any unclear message occurs, please contact NEXCOM customer service representative for help or log onto <http://www.nexcom.com.tw/news/newslst.jsp?iid=Online%20Support>

1 About the BIOS

The BIOS (Basic Input and Output System) Setup program is a menu driven utility that enables you to make changes to the system configuration and tailor your system to suit your individual work needs. It is a ROM-based configuration utility that displays the system's configuration status and provides you with a tool to set system parameters. These parameters are stored in non-volatile battery-backed-up CMOS RAM that saves this information even when the power is turned off. When the system is turned back on, the system is configured with the values found in CMOS.

With easy-to-use pull down menus, you can configure such items as:

- Hard drives, diskette drives, and peripherals
- Video display type and display options
- Password protection from unauthorized use
- Power management features

The settings made in the Setup program intimately affect how the computer performs. Therefore, it is important to understand all the Setup options, and then make appropriate settings.

2 When to Run BIOS

The BIOS program should be modified under the following conditions:

- Changing of the system configuration
- Detecting configuration error by the system and you are prompted to make changes to the Setup program
- Resetting the system clock
- Redefining the communication ports to prevent any conflicts
- Making changes to the Power Management configuration
- Changing the password or making other changes to the security setup

Normally, running CMOS setup is needed when the system hardware is not consistent with the information contained in the CMOS RAM whenever the CMOS RAM has lost power or the system features need to be changed.

3 Entering Setup

When the system is powered on, the BIOS will enter the Power-On Self Test (POST) routines. These routines perform various diagnostic checks; if an error is encountered,

the error will be reported in one of two different ways:

- If the error occurs before the display device is initialized, a series of beeps will be transmitted.
- If the error occurs after the display device is initialized, the screen will display the error message.

Powering on the computer and immediately pressing allows you to enter Setup. Another way to enter Setup is to power on the computer and wait for the following message during the POST:

TO ENTER SETUP BEFORE BOOT
PRESS <CTRL+ALT+DEL > KEY

Press the key or press the <Ctrl>, <Alt>, and <Esc> keys to enter Setup:

4 The Main Menu

Once you enter Award BIOS CMOS Setup Utility, the Main Menu (Figure 1) will appear on the screen. The main menu allows you to select from ten setup functions and two exit choices. Use arrow keys to select among the items and press <Enter> to accept or enter

the sub-menu.

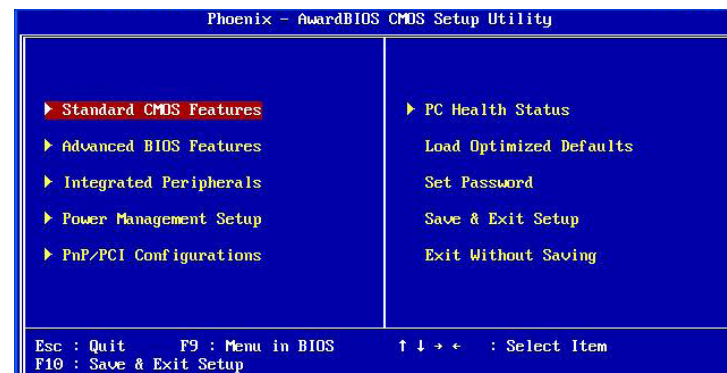

Figure 4-1: BIOS Setup Utility Main Menu

Standard CMOS Features

Use this menu for basic system configuration.

Advanced BIOS Features

Use this menu to set the Advanced Features available on the system.

Integrated Peripherals

Use this menu to specify your settings for integrated peripherals.

Power Management Setup

Use this menu to specify your settings for power management.

PnP/PCI Configurations

This entry appears if your system supports Plug and Play and PCI Configuration.

PC Health Status

Displays CPU, System Temperature, Fan Speed, and System Voltages Value.

Load Optimized Defaults

Use this menu to load the BIOS default values, i.e., factory settings for optimal performance system operations. While Award has designed the custom BIOS to maximize performance, the factory has the option to change these defaults to meet their needs.

Set Password

Enables you to change, set, or disable the supervisor or user password.

Save & Exit Setup

Saves CMOS value changes to CMOS and exits setup

Exit Without Saving

Ignores all CMOS value changes and exits setup.

5 Getting Help













Main Menu



The on-line description of the highlighted setup function is displayed at the bottom of the screen.

Status Page Setup Menu/Option Page Setup Menu

6 Control Keys

The table below lists the keys that help you navigate the setup program.

Up arrow		Move to previous item
Down arrow		Move to next item
Left arrow		Move to the item to the left
Right arrow		Move to the item to the right
Esc key		Main Menu: Quit without saving changes to CMOS Status/Option Page Setup Menus: Exit current page and return to Main Menu.
Enter Key		Select or Accept an Item
PgUp/plus key		Increase the numeric value or make changes
PgDn/minus key		Decrease the numeric value or make changes
F1 key		General help, only for Status Page Setup Menu and Option Page Setup Menu
F2/Shift + F2 key		Change color from total 16 colors. F2 to select color forward, (Shift) F2 to select color backward
F5 key		Restore the previous CMOS value from CMOS (only for Option Page Setup Menu)
F6 key		Load the default CMOS value from BIOS default table (only for Option Page Setup Menu)

F7 key		Load the Setup default value (only for Option Page Setup Menu)
F9 Key		Menu in BIOS
F10 key		Save all the CMOS changes (only for Main Menu)

7 Standard CMOS Features

Selecting Standard CMOS Features on the main program screen displays the following menu:

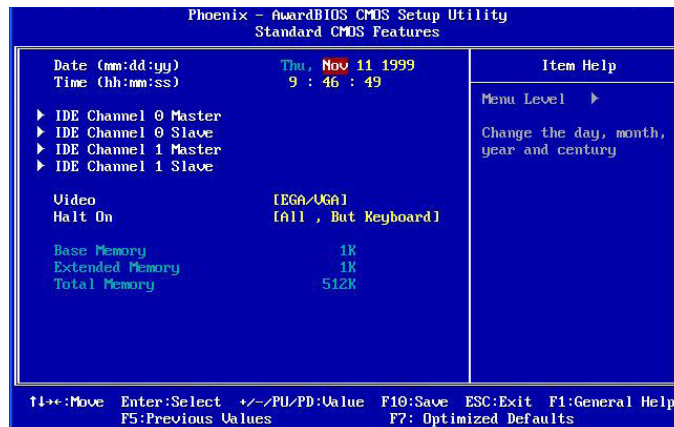

Figure 7-1: BIOS – Standard CMOS Features

The Standard CMOS Setup utility is used to configure the following features:

Date (mm:dd:yy)

The BIOS determines the day of the week from the other data information. This field is for information only. Press the left or right arrow key to move to the desired field (date, month, year). Press the PgUp or PgDn key to increment the setting, or type the desired value into the field.

Time (hh:mm:ss)

The time format is based on the 24-hour military time clock. For example, 1 p.m. is 13:00:00. Press the left or right arrow key to move to the desired field. Press the PgUp or PgDn key to increment the setting, or type the desired value into the field.

IDE Devices (Primary/Secondary Master/Slave)

Your computer has two IDE channels (Primary and Secondary) and each channel can be installed with one or two devices (Master and Slave). Use these items to configure each device on the IDE channel. If you leave this item at Auto, the system will automatically detect and configure any IDE devices it finds. If it fails to find a hard disk, change the value to Manual and then manually configure the drive by entering the characteristics of the drive in the items below:

- Capacity Approximate hard disk drive capacity
- Cylinder Number of cylinders
- Head Number of heads
- Precomp Write pre-compensation cylinder
- Landing Zone Landing zone
- Sector Number of sector

Refer to your drive's documentation or look on the drive if you need to obtain this information. If no device is installed, change the value to None.

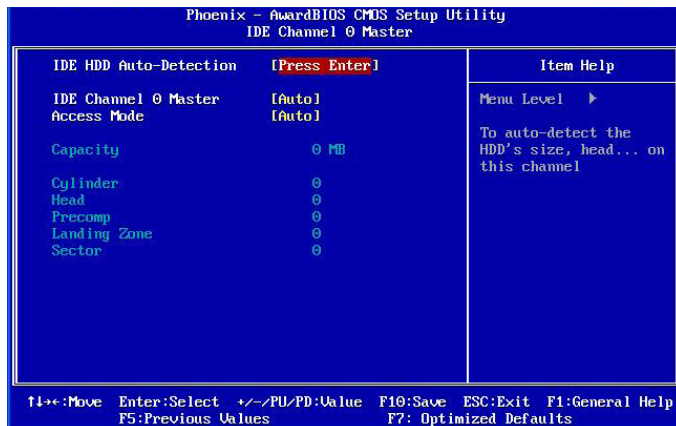

Figure 7-2: IDE channel setting

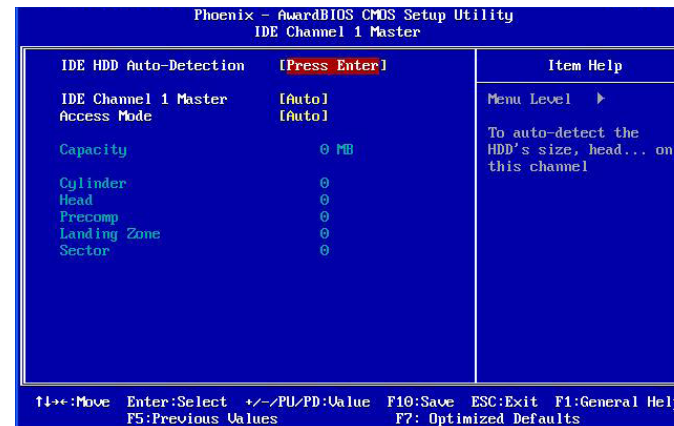

Figure 7-4: IDE channel setting

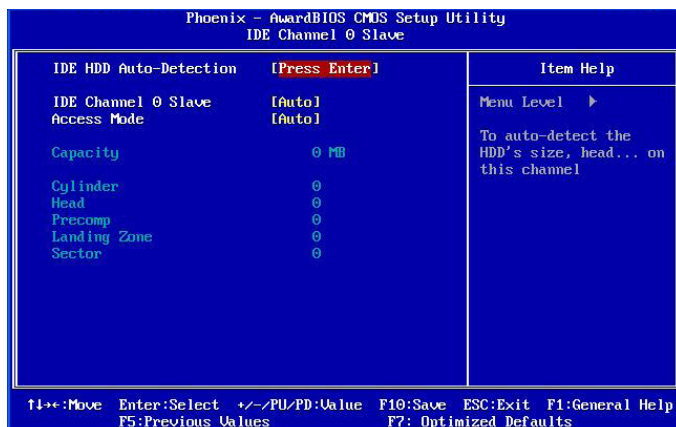

Figure 7-3: IDE channel setting

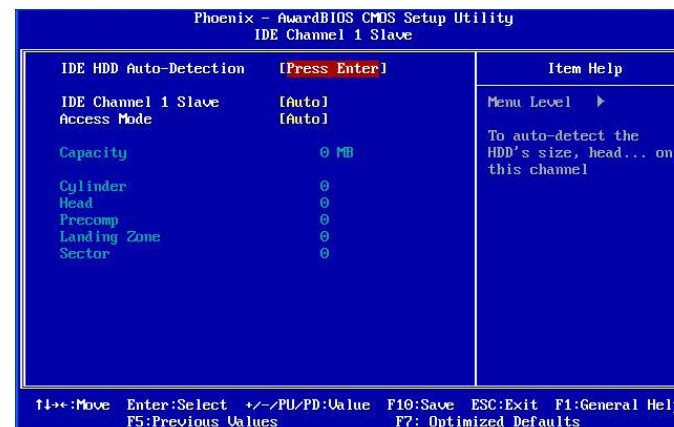

Figure 7-5: IDE channel setting

Video

Set this field to the type of graphics card installed in your system. If you are using a BGA or higher resolution card, choose the EGA/VGA option. The options are:

- EGA/VGA Enhanced Graphics Adapter/Video Graphics Array. For EGA, VGA, SEGA or PGA monitor adapters

Halt On

During the Power-On Self-Test (POST), the computer stops if the BIOS detect a hardware error. This setting determines which type of error will cause the system to halt during boot. The options are:

- All Error: Whenever the BIOS detects a non-fatal error, the system will be stopped and you will be prompted.
- No Errors: The system boot will not stop for any error that may be detected.
- All, But Keyboard: The system boot will not stop for a keyboard error, but it will stop for all others.

After you have made your selections in the Standard CMOS Setup screen, press <ESC> to go back to the main screen.

8 Advanced BIOS Features

Selecting Advanced BIOS Feature on the main program screen displays this menu, which allows you to define advanced information about your system. You can make modifications to most of these items to improve your system performance or set up system features according to your preference, without causing fatal errors to your system.

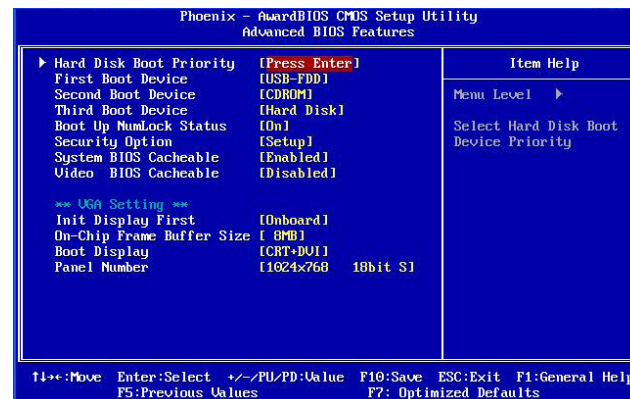

Figure 8-1: BIOS – Advanced BIOS Features

The following explains the options for each feature:

First/Second/Third Boot Device

BIOS attempts to load the operating system from the devices in the sequence selected. The available choices are: Floppy, HDD-0, SCSI, CDROM, HDD-1, HDD-2, HDD-3, USB-FDD, USBZIP, USB-CDROM, USB-HDD, LAN, and Disabled.

Boot Up NumLock Status

Toggle between On or Off to control the state of the NumLock key when the system boot. If On, the numeric keypad is in numeric mode. If Off, the numeric keypad is in cursor control mode.

Security Option

Enables you to select whether the password is required every time the system boots or only when you enter Setup.

- **System:** The system will not boot and access to Setup will be denied if the correct password is not entered at the prompt.
- **Setup:** The system will boot, but access to Setup will be denied if the correct password is not entered at setup.

System BIOS cacheable

Selecting Enabled allows caching of the system BIOS ROM at F0000h-FFFFFh, resulting in better system performance. However, if any program writes to this memory area, a system error may result. The available choices are Enabled, Disabled.

Video BIOS Cacheable

Selecting Enabled allows caching of the video BIOS ROM at C0000h, resulting in better video performance. However, if any program writes to this memory area, a system error may result. The choices:

Enabled, Disabled.

Init Display First

This feature allows you to select whether to boot the system using the onboard AGP graphics card or the PCI graphics card.

On-Chip Frame Buffer Size

The On-Chip Frame Buffer Size can be set as 8MB. This memory is shared with the system memory.

Boot Display

Boot Display determines the display output device where the system boots. The options are Auto, CRT+DVI, and CRT+LVDS.

Panel Type

This field allows user to decide the LVDS panel resolution. Please refer to the BIOS for the resolution.

After you have made your selections in the Advanced Chipset Features setup, press <ESC> to go back to the main screen. The options are 640x480 18bits, 800x600 18bis, 1024x768 18bits.

9 Integrated Peripherals

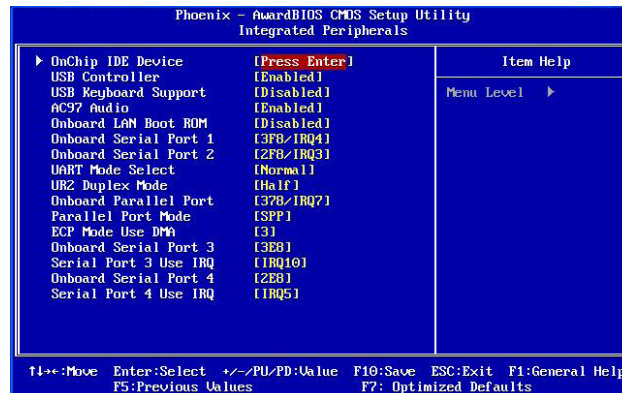

Figure 9-1: BIOS – Integrated Peripherals

OnChip IDE Device

Select this item to setup the IDE device features. When you select this item, the following menu shows:

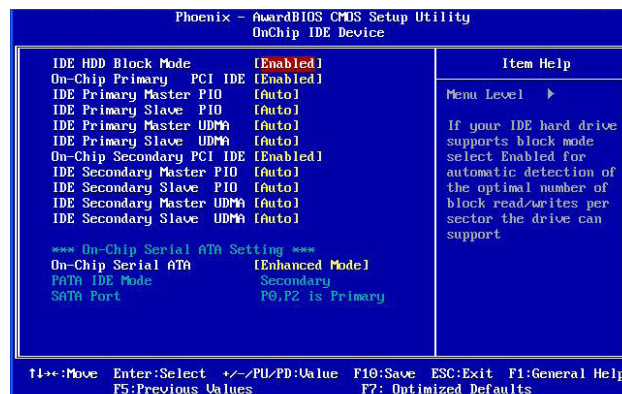

Figure 9-2: On chip IDE Device

USB Controller

Select Enabled if your system contains a Universal Serial Bus 2.0 controller and you have USB 2.0 peripherals.

USB Keyboard Support

Select Enabled if your USB controller is enabled and it needs USB keyboard support in legacy (old) OS operating systems such as DOS.

AC97 Audio

Selecting Auto will enable the AC'97 audio if it is detected onboard.

Onboard LAN Boot ROM

Enables and disables the onboard LAN modules.

Onboard Serial Ports (1, 2, 3, 4)

This feature allows you to manually select the I/O address and IRQ for the first and second serial ports. It is recommended that you leave it as Auto so that the BIOS can select the best settings for it. But if you need a particular I/O port or IRQ that's been taken up by this serial port, you can manually select an alternative I/O port or IRQ for it. You can also disable this serial port if you do not need to use it. Doing so frees up the I/O port and IRQ used by this serial port. Those resources can then be reallocated for other devices to use.

UART Mode Select

Select an operating mode for the serial port.

The choices are: Normal, IrDA, ASKIR.

UR2 Duplex Mode

In an infrared port mode, this field appears. Full-duplex mode permits simultaneous two-direction transmission. Half-duplex mode permits transmission in one direction only at a time. Select the value required by the IR device connected to the IR port.

Onboard Parallel Port

This feature allows you to select the I/O address and IRQ for the onboard parallel port.

The default I/O

address of 378h and IRQ of 7 should work well in most cases. Unless you have a problem with the parallel port, you should leave it at the default settings. The choices: 378/

IRQ7, 278/IRQ5, 3BC/IRQ7, and Disabled.

Parallel Port Mode

Select an operating mode for the onboard parallel (printer) port. There are four options: SPP (Standard Parallel Port), EPP (Enhanced Parallel Port), ECP (Extended Capabilities Port) and ECP+EPP.

ECP Mode Use DMA

When the on-board parallel port is set to ECP mode, the parallel port can use DMA3 or DMA1.

Serial Port 3A Use IRQ

This assigns an IRQ to the serial port 3A.

10 Power Management Setup

This option lets you control system power management. The system has various power-saving modes including powering down the hard disk, turning off the video, suspending to RAM, and software power down that allows the system to be automatically resumed by certain events.

The power-saving modes can be controlled by timeouts. If the system is inactive for a time, the timeouts begin counting. If the inactivity continues so that the timeout period elapses, the system enters a power saving mode. If any item in the list of Reload Global Timer Events is enabled, then any activity on that item will reset the timeout counters to zero.

If the system is suspended or has been powered down by software, it can be resumed by a wake up call that is generated by incoming traffic to a modem, a LAN card, a PCI card, or a fixed alarm on the system realtime clock. Selecting Power Management Setup on the main program screen displays this menu:

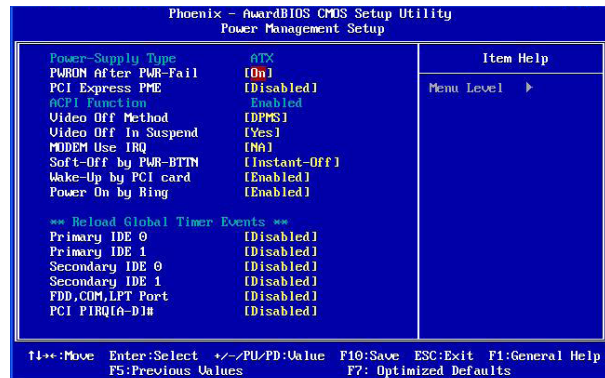

Figure 10-1: BIOS – Power Management Setup

ACPI Function

The ACPI standard (Advanced Configuration and Interface power) allows the operating system directly to check the functions of energy saving and the PnP (Plug and Play)

functionality. The ACPI functions are normally activated by the BIOS. The choices are: Enabled and Disabled.

Video Off Method

This determines the manner in which the monitor is blanked. There are three choices:

1. V/H SYNC+Blank: This selection will cause the system to turn off the vertical and horizontal synchronization port and write blanks to the video buffer.
2. Blank Screen: This option only writes blanks to the video buffer.
3. DPMS Support: Select this option if your monitor supports the Display Power Management signaling (DPMS) standard of the Video Electronics Standard to select video power management values.

Video Off In Suspend

This determines the manner in which the monitor is blanked. The choices: Yes, No.

Wake up by PCI Card

When the system enters a Soft-off mode (Standby power exists but system is not working), it will wake up system when specific signals occurred. The BIOS monitors the system for “activity” to determine when to enable power management.

If you enable this feature, the computer specifies that any signal noticed on the PCI (Peripheral Component Interconnect) bus channel must make go out from the hibernation state. The choices: Enabled, Disabled.

Reload Global Timer Events

Primary/Secondary IDE 0/1
FDD, COM, LPT Port
PCI PIRQ [A-D]#

The events are I/O events whose occurrence can prevent the system from entering a power saving mode or can awaken the system from such a mode. In effect, the system remains alert for anything, which occurs to a device, which is configured as Enabled, even when the system is in a power down mode. The choices are Enabled, and Disabled.

After you have made your selections in the Power Management setup, press the <ESC> key to go back to the main program screen.

11 PnP/PCI Configurations

This section describes configuring the PCI bus system. Peripheral Component Interface, is a system which allows I/O devices to operate at speeds nearing the speed the CPU itself uses when communicating with its own special components. This section covers some very technical items and it is strongly recommended that only experienced users should make any changes to the default settings.

Selecting PnP/PCI Configurations on the main program screen displays this menu:

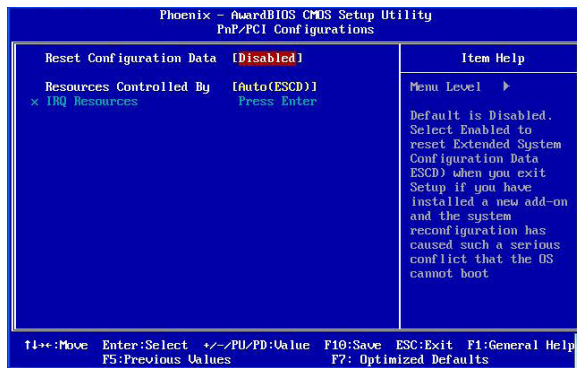

Figure 11-1: BIOS – PnP/PCI Configurations

Reset Configuration Data

Normally, you leave this field Disabled, Select Enabled to reset Extended System Configuration Data (ESCD) when you exit Setup if you have installed a new add-on Card and the system reconfiguration has caused such a serious conflict that the operating system can not boot. The choices are Enabled and Disabled.

Resources Controlled By

The Award Plug and Play BIOS has the capacity to automatically configure all of the boot and Plug and Play compatible devices.

However, this capability means absolutely nothing unless you are using a Plug and Play operating system such as going into each of the submenus that follows this field. The choices are Auto (ESCD), Manual.

12 PC Health Status

When main boards support hardware monitoring, this item lets you monitor the parameters for critical voltages, critical temperatures, and fan speeds. These are the read only items.

After you have read the PC Health Status, press the <ESC> key to go back to the main program screen.

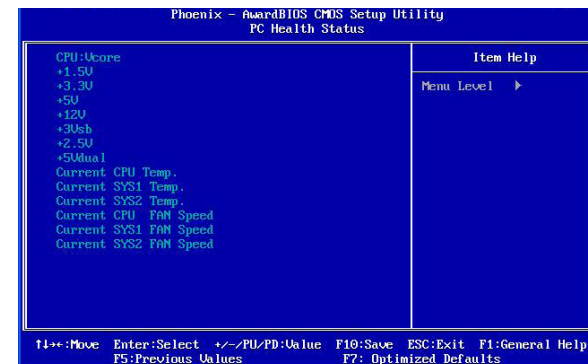

Figure 12-1: PC Health Status

13 Optimized Defaults

This option opens a dialog box that lets you install optimized defaults for all appropriate items in the whole setup utility. Press the <Y> key and then <Enter> to install the defaults. Press the <N> key and then <Enter> to not install the defaults. The optimized defaults place demands on the system that may be greater than the performance level of the components, such as the CPU and the memory. You can cause fatal errors or instability if you install the optimized defaults when your hardware does not support them. If you only want to install setup defaults for a specific option, select and display that option, and then press the <F7> key.

14 Set Password

The User Password utility sets the password. The main board is shipped with the password disabled. If you want to change the password, you must first enter the current password, then at the prompt enter your new password. The password is case sensitive. You can use up to eight alphanumeric characters. Press <Enter> after entering the password. At the next prompt, confirm the new password by retyping it and pressing <Enter> again.

To disable the password dialog box appears. A message appears confirming that the password has been disabled. If you have set supervisor and user Password, only the supervisor password allows you to enter the BIOS setup program.

Note: If you forget your password, the only way to solve this problem is to discharge the CMOS memory by turning power off and placing a shunt (jumper cap) on jumper JP2 to short pin 2 and pin 3 for five seconds, then putting the shunt back to pin 1 and pin 2 of JP2.

15 Save & Exit Setup

Selecting this option and pressing <Enter> will save the new setting information in the CMOS memory and continue with the booting process.

16 Exit Without Saving

Selecting this option and pressing <Enter> will exit the Setup utility without recording any new values or changing old ones.